



*Canyon Ridge® / Chevron, Design 52; Shown in Color Blast® Custom Color with Mahogany Cladding, Mahogany Overlays and REC14 Window Design
Photo Credit: Andy Frame Photography*

WINDCODE®
ARE YOU READY FOR THE STORM?
Florida Edition - Based on ASCE7-22 code



America's Favorite Garage Doors®



WINDCODE® GARAGE DOORS

DETERMINE YOUR WINDCODE® RATING

Clopay assigns a WINDCODE® "W" rating to our doors based on code requirements determined by wind speed in miles per hour (MPH), home exposure and home structural type.

STEP 1:

- Determine the minimum wind speed (MPH) your door must meet or exceed from the map below, or go to www.atcouncil.org/windspeed. Determine if wind-borne debris is applicable. See map below.

Please refer to Risk Category II when using ATC Wind Speed calculator for residential applications.

WIND-BORNE DEBRIS

The wind-borne debris region is also known as those areas that require the large missile impact rated windows. In Florida, being farther south and closer to the shoreline, it is more likely a home or building will be in the wind-borne debris region.

HIGH VELOCITY HURRICANE ZONE (HVHZ)

Miami-Dade and Broward Counties require all garage doors meet the large missile impact rating, regardless if the garage door has windows or not.

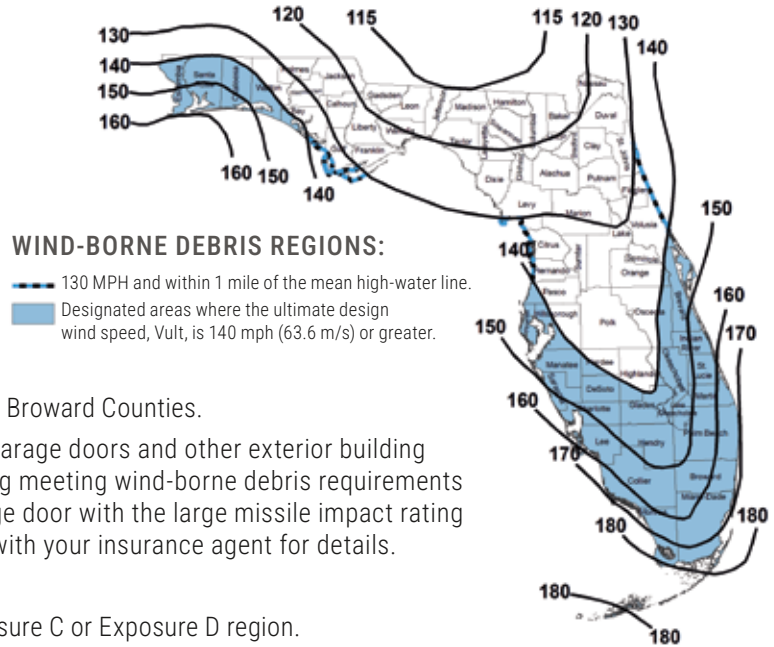

Standard windows are not available in Miami-Dade and Broward Counties.

Insurance companies sometimes give discounts for garage doors and other exterior building products that exceed the local building code, including meeting wind-borne debris requirements not mandated. This means that installing a new garage door with the large missile impact rating may reduce your insurance premiums. Please check with your insurance agent for details.

STEP 2:

- Determine if your home is in an Exposure B, Exposure C or Exposure D region.

- Exposure B is defined as urban and suburban areas, wooded areas or other terrain with numerous closely spaced obstructions.
- Exposure C is defined as open terrain with scattered obstructions including flat open ground and grasslands. All of Miami-Dade and Broward Counties are Exposure C, unless it meets Exposure D definition.
- Exposure D is defined as being within 600 feet of the ocean front or other large body of water measuring at least 5,000 feet across. Contact building code official or DASMA Technical Data Sheet TDS-155x for design pressures.

STEP 3:

- Determine the structural type of your home.

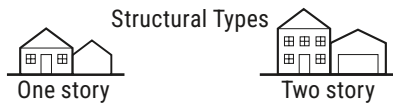

STEP 4:

- Using wind speed (MPH), exposure and structural type, find your required design pressure and WINDCODE® "W" rating in the charts on page 3.

Note: It is important to also contact your homeowner's insurance company. Many insurance companies may require or encourage doors that are different than required by building code.

Additional requirements may be requested by building code officials such as flood resistant construction. Typically garage doors are NOT part of this requirement. See details in DASMA TDS-184.

HELPFUL LINKS:

For Florida building code and product approvals visit:

www.floridabuilding.org

For Dade product approvals visit:

www.miamidade.gov/building/product-control.asp

For Industry Technical Data Sheet (DASMA TDS) visit:

www.dasma.com/dasma-pages/DASMA-technical-data-sheets.asp

For easy access to up-to-date drawings and evaluation reports,

visit: www.clopaydoor.com/residential/windcode-residential-information/residential-windcode-calculator

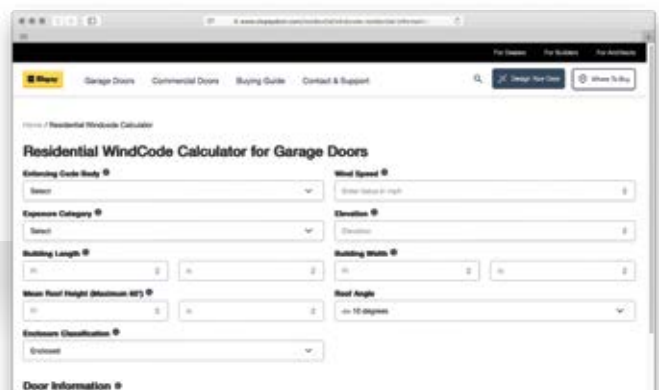

DESIGN PRESSURES

The design wind load pressure rating of a door is expressed in PSF (pounds per square foot). The design pressure of the door must equal or exceed the design pressure for the garage door opening in which a door is to be installed. Design pressure has positive and negative values.

GARAGE DOOR WIND LOAD GUIDE – VALUES IN PSF												
Mean Roof Height	Door Size	Based on the 8th Edition Florida Building Code & ASCE7-22, Exposure B, 115 – 200 MPH Ultimate Design Wind Speed, MPH (V _{ult})										
	Ultimate Wind Speed →	115 MPH	120 MPH	130 MPH	140 MPH	150 MPH	160 MPH	170* MPH	175** MPH	180 MPH	190 MPH	200 MPH
15 Feet Single Story	Single 9' x 7'	10.3 -11.6	11.2 -12.7	13.2 -14.9	15.2 -17.1	17.5 -19.8	19.9 -22.6	22.6 -25.6	23.9 -27.0	25.1 -28.4	28.0 -31.7	31.2 -35.3
	Double 16' x 7'	9.8 -11.0	10.7 -12.0	12.7 -14.1	14.5 -16.2	16.7 -18.6	19.1 -21.3	21.6 -24.1	22.8 -25.4	24.0 -26.7	26.8 -29.9	29.8 -33.3
25 Feet Double Story	Single 9' x 7'	11.8 -13.3	12.9 -14.6	15.1 -17.1	17.4 -19.6	20.0 -22.7	22.8 -25.9	25.9 -29.3	27.4 -30.9	28.8 -32.5	32.1 -36.3	35.7 -40.4
	Double 16' x 7'	11.3 -12.6	12.3 -13.7	14.6 -16.2	16.6 -18.5	19.2 -21.3	21.9 -24.4	24.8 -27.6	26.2 -29.1	27.5 -30.6	30.7 -34.3	34.2 -38.2
	Equivalent Nominal Wind Speed →	89 MPH	93 MPH	101 MPH	108 MPH	116 MPH	124 MPH	132 MPH	136 MPH	139 MPH	147 MPH	155 MPH
Mean Roof Height	Door Size	Based on the 8th Edition Florida Building Code & ASCE7-22, Exposure C, 115 – 200 MPH Ultimate Design Wind Speed, MPH (V _{ult})										
	Ultimate Wind Speed →	115 MPH	120 MPH	130 MPH	140 MPH	150 MPH	160 MPH	170* MPH	175** MPH	180 MPH	190 MPH	200 MPH
15 Feet Single Story	Single 9' x 7'	15.2 -17.2	16.6 -18.8	19.5 -22.0	22.4 -25.3	25.8 -29.2	29.4 -33.3	33.4 -37.8	35.2 -39.8	37.0 -41.9	41.4 -46.7	46.0 -52.0
	Double 16' x 7'	14.5 -16.2	15.9 -17.7	18.8 -20.8	21.4 -23.8	24.7 -27.5	28.2 -31.5	31.9 -35.6	33.7 -37.5	35.5 -39.4	39.6 -44.2	44.0 -49.1
25 Feet Double Story	Single 9' x 7'	16.9 -19.2	18.5 -20.9	21.7 -24.6	25.0 -28.2	28.8 -32.5	32.8 -37.1	37.3 -42.1	39.3 -44.4	41.3 -46.7	46.2 -52.1	51.3 -58.1
	Double 16' x 7'	16.2 -18.1	17.7 -19.7	20.9 -23.2	23.9 -26.6	27.5 -30.6	31.5 -35.1	35.6 -39.7	37.6 -41.9	39.6 -44.0	44.1 -49.3	49.1 -54.8
	Equivalent Nominal Wind Speed →	89 MPH	93 MPH	101 MPH	108 MPH	116 MPH	124 MPH	132 MPH	136 MPH	139 MPH	147 MPH	155 MPH
Mean Roof Height	Door Size	Based on the 8th Edition Florida Building Code & ASCE7-22, Exposure D, 115 – 200 MPH Ultimate Design Wind Speed, MPH (V _{ult})										
	Ultimate Wind Speed →	115 MPH	120 MPH	130 MPH	140 MPH	150 MPH	160 MPH	170 MPH	175 MPH	180 MPH	190 MPH	200 MPH
15 Feet Single Story	Single 9' x 7'	18.4 -20.9	20.1 -22.8	23.7 -26.8	27.2 -30.7	31.3 -35.4	35.7 -40.4	40.6 -45.9	42.8 -48.4	45.0 -50.9	50.3 -56.7	55.9 -63.2
	Double 16' x 7'	17.6 -19.7	19.3 -21.5	22.8 -25.3	26.0 -29.0	30.0 -33.4	34.3 -38.2	38.8 -43.2	40.9 -45.6	43.1 -47.9	48.1 -53.7	53.5 -59.7
25 Feet Double Story	Single 9' x 7'	20.2 -22.9	22.1 -25.0	25.9 -29.3	29.8 -33.6	34.3 -38.8	39.1 -44.3	44.4 -50.2	46.9 -53.0	49.3 -55.7	55.1 -62.1	61.2 -69.2
	Double 16' x 7'	19.3 -21.6	21.1 -23.5	25.0 -27.7	28.5 -31.7	32.8 -36.5	37.5 -41.9	42.5 -47.3	44.8 -49.9	47.2 -52.5	52.6 -58.8	58.6 -65.4
	Equivalent Nominal Wind Speed →	89 MPH	93 MPH	101 MPH	108 MPH	116 MPH	124 MPH	132 MPH	136 MPH	139 MPH	147 MPH	155 MPH

*Broward County is 170 MPH, Exposure C for most residential buildings. **Miami-Dade County is 175 MPH, Exposure C for most residential buildings. The design pressures listed are the minimum required. Recommended WINDCODE® levels typically meet or exceed the required design pressures. MPH = miles per hour PSF = pounds per square foot

WINDCODE® “W” RATING GUIDE											
EXPOSURE B											
Structural Type	115 MPH	120 MPH	130 MPH	140 MPH	150 MPH	160 MPH	170 MPH	180 MPH	190 MPH	200 MPH	
One Story	W1	W2	W3	W3	W4	W5	W5	W6	W6	W7	
Two Story	W1	W2	W3	W3	W4	W5	W5	W6	W6	W7	
EXPOSURE C											
Structural Type	115 MPH	120 MPH	130 MPH	140 MPH	150 MPH	160 MPH	170* MPH	175** MPH	180 MPH	190 MPH	200 MPH
One Story	W2	W3	W3	W4	W5	W5/W6	W6/W7	W6/W7	W7	W7	W8
Two Story	W3	W3	W4	W5	W5/W6	W6	W6/W7	W7/W8	W7/W8	W8	W9
EXPOSURE D											
Structural Type	115 MPH	120 MPH	130 MPH	140 MPH	150 MPH	160 MPH	170 MPH	175 MPH	180 MPH	190 MPH	200 MPH
One Story	W3	W3/W4	W4/W5	W5	W6	W6	W7	W7/W8	W7/W8	W8	W9
Two Story	W3/W4	W4/W5	W4/W5	W5/W6	W6	W7/W8	W7/W8	W8	W8	W9	W9

*Broward County is 170 MPH, Exposure C for most residential buildings. **Miami-Dade County is 175 MPH, Exposure C for most residential buildings. MPH = miles per hour



WINDCODE® GARAGE DOORS

STORM READY® – NO POSTS, PINS OR EXTRA SETUP. JUST CLOSE AND LOCK YOUR DOOR.

WINDCODE® BENEFITS

- No attachments to the floor or structure required
- No extra posts, pins, parts or setup necessary
- Storm ready, simply close and lock your door

STANDARD GARAGE DOOR



WINDCODE® GARAGE DOORS

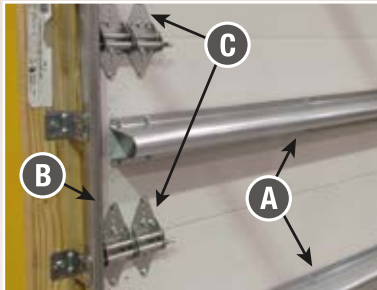

- A** Patented T-Strut design strengthens door
- B** Heavy-duty commercial grade track provides additional strength and durability
- C** Commercial-duty steel rollers and hardware withstand more severe wind pressures

CLOPAY'S WINDCODE® GARAGE DOORS

Clopay's WindCode® garage doors are designed to help withstand high winds resulting from tropical storms and other strong wind-related weather events. This user-friendly system assists you in selecting the right garage door for your area and building structure.

DESIGN OPTIONS

Clopay's WindCode® product offering has the widest range of panel styles, colors and window designs available today. Accent the design of your home while providing the protection you need against strong winds. Choose from various panel designs and Designer or Decorative windows for that extra curb appeal. Impact-resistant windows are available in many different colors and wind load levels.

DESIGNED AND TESTED TO WITHSTAND STRONG WINDS

All Clopay WindCode® doors have been designed and tested to meet various code requirements. Additional interior horizontal steel reinforcement along with increased hardware and springing components are installed so your door is ready when a storm hits. No posts or pins are required to secure your door if you are not there. Just lock your door.

OPTIONS AND UPGRADES

HEAVY-DUTY HARDWARE WITH QUIETFLEX™ HINGES

- Quieter, longer-lasting nylon ball-bearing rollers
- Quieter, stronger, wider and longer-lasting heavy-duty QuietFlex™ 14 gauge hinges



intelllicore® insulation technology

**COOLER
QUIETER
STRONGER**

Garage doors featuring Intellicore® insulation technology represent the ultimate smart choice for homeowners. Clopay's Intellicore® insulation is a proprietary polyurethane foam that is injected into a garage door, expanding to fill the entire structure. The result is a door with incredible strength and durability. Its dense insulation also produces a quieter door, while its industry-leading R-values (up to 20.4) provide year-round comfort and improved energy efficiency.



Look for the Intellicore® insulation technology icon throughout this brochure on select door models.

CANYON RIDGE® Modern



Canyon Ridge® Modern door designs feature key elements of contemporary architecture: clean, horizontal lines with mid-century appeal, sleek window styles and aluminum accents.

STYLE AND CONSTRUCTION

- Plank design: Faux-wood doors with Intellicore® polyurethane insulation (R-value 20.4).
- Metal Inlay design: Faux-wood doors with Intellicore® polyurethane insulation (R-value 18.4).
- Full-View design: Faux-wood doors with Intellicore® polyurethane insulation (R-value 6.3).
- Replaceable vinyl bottom weatherseal in a corrosion-resistant retainer helps seal out the elements.

Calculated door section R-value is in accordance with DASMA TDS-163.

DOOR DESIGNS Custom designs available, contact Clopay for availability.

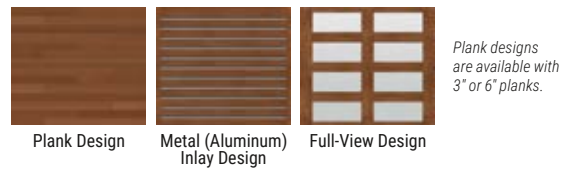

WINDOW OPTIONS



PLANK WINDOW CONFIGURATIONS

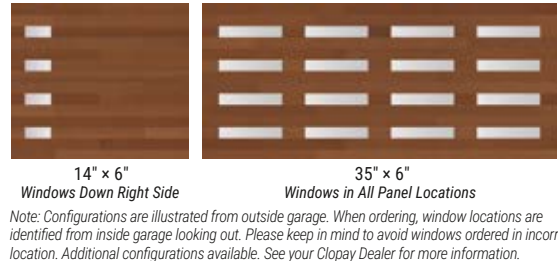

MATERIAL DESIGN OPTIONS

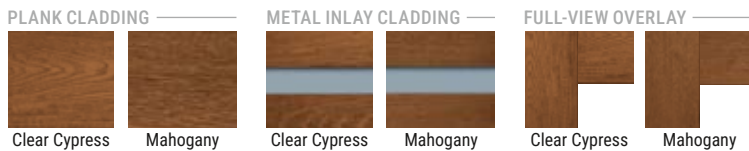

FINISHING AND CARE: Proper care and maintenance are imperative for long-term performance and appearance of Canyon Ridge® garage doors. Periodic inspection and maintenance of the composite cladding and overlays are required. Complete finishing and maintenance instructions are provided with the door and are also available from your Clopay Dealer or online at www.clopaydoor.com.

COLOR OPTIONS

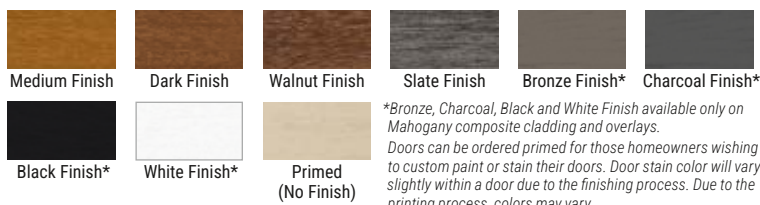

SPECIALTY GLASS OPTIONS



WINDCODE® AVAILABILITY CHART

Common Door Widths		W1	W3	W4	W5	W6	W7	W8		
Model CRM	8', 9' Wide Door	S +13/-15 PSF	SELECT W6	SELECT W6	SELECT W6	PLANK/FULL-VIEW FTWS +38/-42 PSF	METAL INLAY FTWS +38/-44 PSF	SELECT W8	PLANK/FULL-VIEW FTWS +54/-62 PSF	METAL INLAY FW +54/-60 PSF
	10', 12' Wide Door	S +12.5/-14 PSF	SELECT W6	SELECT W6	SELECT W6	PLANK/FULL-VIEW FTWS +38/-42 PSF	METAL INLAY FTWS +38/-42 PSF	SELECT W8	PLANK/FULL-VIEW FTWS +50/-56 PSF	METAL INLAY FW +46/-52 PSF
	16' Wide Door	S +12.5/-14 PSF	SELECT W6	SELECT W6	SELECT W6	PLANK/FULL-VIEW FTWS +38/-42 PSF	METAL INLAY FTWS +38/-42 PSF	SELECT W8	PLANK/FULL-VIEW FTWS +46/-52 PSF	METAL INLAY FW +46/-52 PSF
	18' Wide Door	S +12.5/-14 PSF	SELECT W6	SELECT W6	SELECT W6	PLANK/FULL-VIEW FT +38/-42 PSF	METAL INLAY FTWS +38/-42 PSF			

S Standard Windows Available W Patented Impact Windows Available
 ☉ Impact Rated F Florida Approved D Dade County Approved
 T Texas Department of Insurance Approved

For W6-W8 doors over 10'2" wide, add 2" to the door width.

CANYON RIDGE® Carriage House

5-LAYER CONSTRUCTION

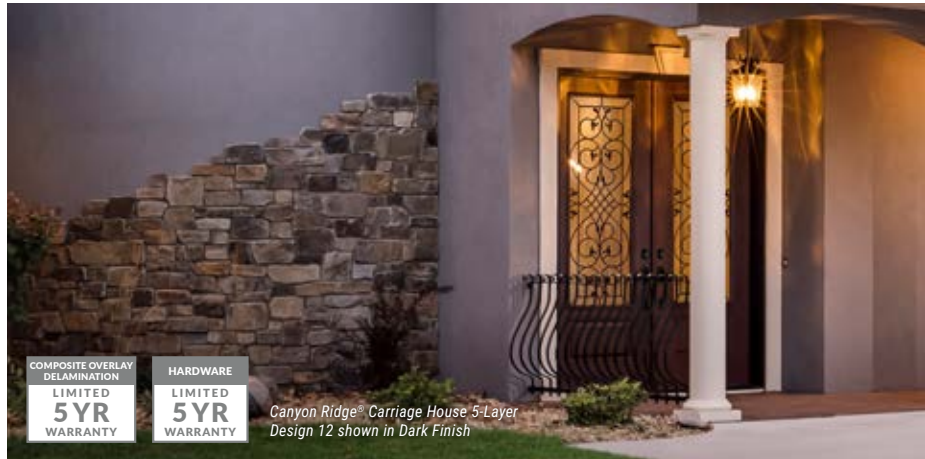

Canyon Ridge® Carriage House 5-Layer doors are constructed of durable, low-maintenance steel and composite. These faux-wood alternatives offer the best of both worlds – the realism and beauty of a natural stained-wood appearance combined with the strength and energy efficiency of insulated steel.

STYLE AND CONSTRUCTION

- 5-layer construction, 2" thick IntellCore® polyurethane insulation (R-value 20.4).
- Attractive beveled edge, clip-in grilles are removable for easy cleaning.
- Replaceable vinyl bottom weatherseal in a corrosion-resistant retainer helps seal out the elements.
- 10-ball nylon rollers for quiet operation.
- Heavy-duty 14 gauge steel hinges for long-lasting performance.

Calculated door section R-value is in accordance with DASMA TDS-163.

DOOR DESIGNS

Custom designs available, contact Clopay for availability.

SERIES 1



SERIES 2



SERIES 3



Doors shown in Dark Finish with Clear Cypress cladding and Clear Cypress overlays. Design 01 does not have an overlay.

WINDCODE® AVAILABILITY CHART								
Common Door Widths	W1	W3	W4	W5	W6	W7	W8	
Model CAN	8', 9' Wide Door	S +13/-15 PSF	SELECT W4	FS +28/-29 PSF	FS +30/-32 PSF	FTDWS +38/-44 PSF	SELECT W8	FDW +54/-60 PSF
	10', 12' Wide Door	S +12.5/-14 PSF	SELECT W4	FS +25.5/-25.5 PSF	FS +30/-30 PSF	TAPERED STRUT FTDWS +38/-42 PSF	SELECT W8	TAPERED STRUT FDW +46/-52 PSF
	16' Wide Door	S +12.5/-14 PSF	SELECT W4	FS +25.5/-25.5 PSF	FS +30/-30 PSF	TAPERED STRUT FTDWS +38/-42 PSF	SELECT W8	TAPERED STRUT FDW +46/-52 PSF
	18' Wide Door	S +12.5/-14 PSF	SELECT W4	F +25/-25 PSF	SELECT W6	TAPERED STRUT FTDWS +38/-42 PSF		
S Standard Windows Available Impact Rated		W Patented Impact Windows Available F Florida Approved			D Dade County Approved T Texas Department of Insurance Approved			

For W6 – W8 doors over 10'2" wide, add 2" to the door width.

CANYON RIDGE® Carriage House

5-LAYER CONSTRUCTION



MATERIAL DESIGN OPTIONS

CLADDING MATERIALS



Clear Cypress



Mahogany

OVERLAY MATERIALS



Clear Cypress



Pecky Cypress



Mahogany

Cladding and overlay material options may be mixed and matched.

FINISHING AND CARE: Proper care and maintenance are imperative for long-term performance and appearance of Canyon Ridge® garage doors. Periodic inspection and maintenance of the composite cladding and overlays are required. Complete finishing and maintenance instructions are provided with the door and are also available from your Clopay Dealer or online at www.clopaydoor.com.

COLOR OPTIONS



Medium Finish



Dark Finish



Walnut Finish

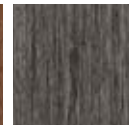

Slate Finish



Bronze Finish*



Charcoal Finish*



Black Finish*



White Finish*



Primed
(No Finish)

*Bronze, Charcoal, Black and White Finish available only on Mahogany cladding and overlays. Two-tone doors are available. To see all available options go to: dis.clopay.com. Doors can be ordered primed for those homeowners wishing to custom paint or stain their doors. Door stain color will vary slightly within a door due to the finishing process. Due to the printing process, colors may vary.

WINDOW OPTIONS



REC11

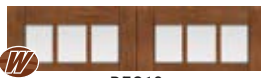

REC13

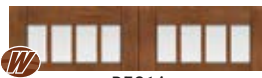

REC14



SQ23

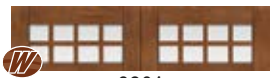

SQ24



ARCH1



ARCH13



ARCH14



ARCH3

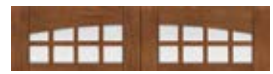

ARCH4

Window grilles are Clear Cypress texture. Windows not available on Designs 01, 31, 32, 33, 34, 35, 36, 37 and 38. Double door designs also available.

Standard windows available on the following widths only: 6'2", 8'0", 9'0", 10'0", 10'2", 12'0", 12'2", 13'6", 15'0", 15'2", 15'6", 15'8", 16'0", 16'2", 18'0", 18'2", 20'0", 20'2".

Impact rated windows available on the following widths only: 8'0", 9'0", 10'0", 12'2", 16'2", 18'2". To view additional designs, windows and top sections available, please visit www.clopaydoor.com.



Impact rated windows available.

SPECIALTY GLASS OPTIONS

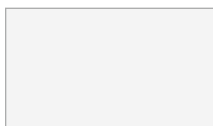

Clear

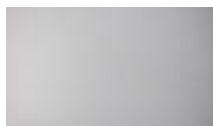

Frosted



Seeded



Obscure



Rain



Clear Polycarbonate

Windows are available insulated in clear, frosted, seeded, obscure and rain.

Impact rated windows are available in clear polycarbonate and may have a wavy appearance.

CANYON RIDGE® Carriage House

4-LAYER CONSTRUCTION

HANDCRAFTED 4-LAYER CONSTRUCTION



- 1 COMPOSITE OVERLAY
- 2 STEEL WITH ULTRA-GRAIN® FINISH (SHOWN) OR SOLID COLOR STEEL
- 3 2" INTELLICORE® POLYURETHANE INSULATION
- 4 STEEL



COMPOSITE OVERLAY DELAMINATION LIMITED 5YR WARRANTY	HARDWARE LIMITED 5YR WARRANTY	STEEL PAINT SYSTEM LIMITED LIFE WARRANTY
---	---	--

Canyon Ridge® Carriage House 4-Layer Design 21 shown in Slate Finish with SQ24 Windows
Photo Credit: Living Stone Design + Build, Ryan Theede Photography

Canyon Ridge® Carriage House 4-Layer base doors are available in Ultra-Grain® finish and solid colors for the perfect complement to your home. The overlay materials are molded from actual wood to reproduce the natural texture and grain patterns of the species that they emulate. The combination of steel and overlay creates a distinct look.

STYLE AND CONSTRUCTION

- 4-layer construction, 2" thick Intellicore® polyurethane insulation (R-value 18.4).
- Attractive beveled edge, clip-in grilles are removable for easy cleaning.
- Replaceable vinyl bottom weatherseal in a corrosion-resistant retainer helps seal out the elements.
- 10-ball nylon rollers for quiet operation.
- Heavy-duty 14 gauge steel hinges for long-lasting performance.

Calculated door section R-value is in accordance with DASMA TDS-163.

DOOR DESIGNS

Custom designs available, contact Clopay for availability.

SERIES 1

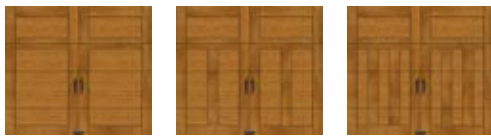

Design 11 Design 12 Design 13

SERIES 3

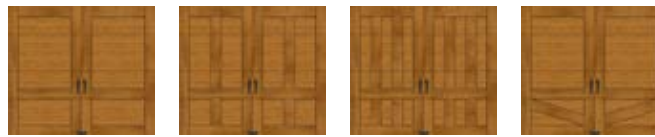

Design 31 Design 32 Design 33 Design 34

SERIES 2



Design 21 Design 22 Design 23



Design 35 Design 36 Design 37 Design 38

All doors shown in Medium Finish with Clear Cypress overlays.

WINDCODE® AVAILABILITY CHART

Common Door Widths		W1	W3	W4	W5	W6	W7	W8
Model CAN	8', 9' Wide Door	S +13/-15 PSF	SELECT W4	FS +28/-29 PSF	FS +30/-32 PSF	FTDWS +38/-44 PSF	SELECT W8	FDW +54/-60 PSF
	10', 12' Wide Door	S +12.5/-14 PSF	SELECT W4	FS +25.5/-25.5 PSF	FS +30/-30 PSF	TAPERED STRUT FTDWS +38/-42 PSF	SELECT W8	TAPERED STRUT FDW +46/-52 PSF
	16' Wide Door	S +12.5/-14 PSF	SELECT W4	FS +25.5/-25.5 PSF	FS +30/-30 PSF	TAPERED STRUT FTDWS +38/-42 PSF	SELECT W8	TAPERED STRUT FDW +46/-52 PSF
	18' Wide Door	S +12.5/-14 PSF	SELECT W4	F +25/-25 PSF	SELECT W6	TAPERED STRUT FTDWS +38/-42 PSF		

S Standard Windows Available
I Impact Rated

W Patented Impact Windows Available
F Florida Approved

D Dade County Approved
T Texas Department of Insurance Approved

For W6 - W8 doors over 10'2" wide, add 2" to the door width.

CANYON RIDGE® Carriage House

4-LAYER CONSTRUCTION



MATERIAL DESIGN OPTIONS

STEEL BASE MATERIAL



Ultra-Grain® Finish Clear Cypress or Solid Color Steel

Composite cladding is not present on Carriage House 4-Layer doors.

OVERLAY MATERIALS



Clear Cypress



Mahogany

FINISHING AND CARE: Proper care and maintenance are imperative for long-term performance and appearance of Canyon Ridge® garage doors. Periodic inspection and maintenance of the composite cladding and overlays are required. Complete finishing and maintenance instructions are provided with the door and are also available from your Clopay Dealer or online at www.clopaydoor.com.

COLOR OPTIONS



Ultra-Grain® Cypress Medium Finish

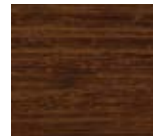

Ultra-Grain® Cypress Walnut Finish



Ultra-Grain® Cypress Slate Finish



Bronze Finish*

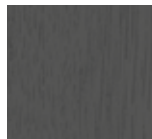

Charcoal Finish*



Black Finish*



White Finish*



Primed (No Finish)

*Bronze, Charcoal, Black and White Finish available only on Mahogany overlays. Two-tone doors are available. To see all available options go to: dis.clopay.com. Steel surfaces have woodgrain texture.

Doors can be ordered primed for those homeowners wishing to custom paint their doors. Note: Primed solid steel base is a brown color. Door stain color will vary slightly within a door due to the finishing process. Due to the printing process, above colors may vary.

WINDOW OPTIONS



REC11



REC13



REC14



SQ23



SQ24



ARCH1



ARCH13



ARCH14



ARCH3



ARCH4

Window grilles are Clear Cypress texture. Windows not available on Designs 31, 32, 33, 34, 35, 36, 37 and 38. Double door designs also available.

Standard windows available on the following widths only: 6'2", 8'0", 9'0", 10'0", 10'2", 12'0", 12'2", 13'6", 15'0", 15'2", 15'6", 15'8", 16'0", 16'2", 18'0", 18'2", 20'0", 20'2".

Impact rated windows available on the following widths only: 8'0", 9'0", 10'0", 12'2", 16'2", 18'2". To view additional designs, windows and top sections available, please visit www.clopaydoor.com.

Impact rated windows available.

SPECIALTY GLASS OPTIONS

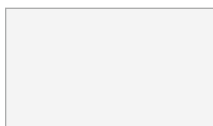

Clear



Frosted



Seeded



Obscure



Rain



Clear Polycarbonate

Windows are available insulated in clear, frosted, seeded, obscure and rain.

Impact rated windows are available in clear polycarbonate and may have a wavy appearance.

CANYON RIDGE® Elements

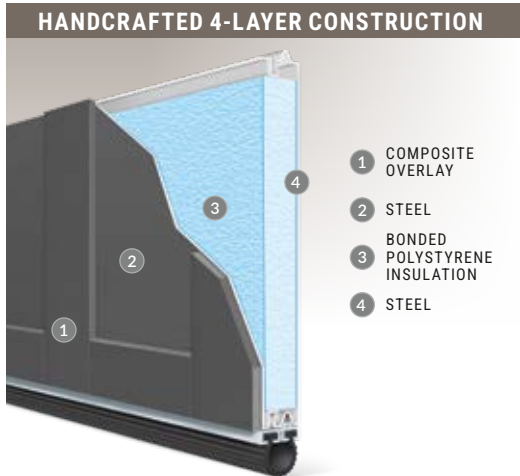

The introductory model in our top-selling line of faux-wood carriage house doors, Canyon Ridge® Elements pairs moisture-resistant composite overlays featuring clean, square “Shaker” edges and durable, insulated steel to give you the look of painted wood without the upkeep. Choose from 13 designs in 7 finishes including dramatic dark colors like Charcoal, Black and Bronze.

STYLE AND CONSTRUCTION

- 4-layer, steel and composite overlay doors with 1-3/8" bonded polystyrene insulation (6.5 R-value).
- Attractive beveled edge, clip-in grilles are removable for easy cleaning.
- Replaceable vinyl bottom weatherseal in a corrosion-resistant retainer helps seal out the elements.
- 10-ball nylon rollers for quiet operation.
- Heavy-duty 14 gauge steel hinges for long-lasting performance.

Calculated door section R-value is in accordance with DASMA TDS-163.

DOOR DESIGNS *Custom designs available, contact Clopay for availability.*

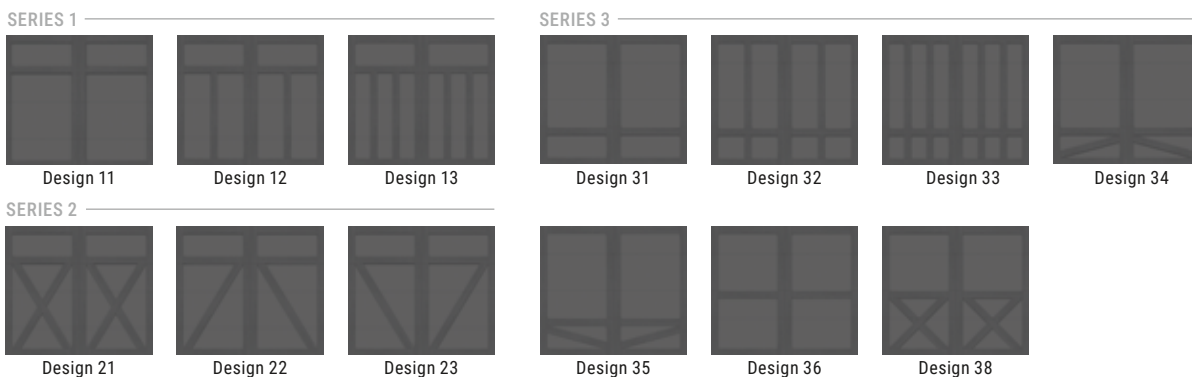

All doors designs shown in Charcoal with woodgrain classic steel base and overlays

WINDCODE® AVAILABILITY CHART								
Common Door Widths		W1	W3	W4	W5	W6	W7	W8
Model CED	8', 9' Wide Door	S +13/-15 PSF						
	10', 12' Wide Door	S +12.5/-14 PSF						
	16' Wide Door	S +12.5/-14 PSF						
	18' Wide Door	S +12.5/-14 PSF						
S Standard Windows Available I Impact Rated		W Patented Impact Windows Available F Florida Approved			D Dade County Approved T Texas Department of Insurance Approved			

CANYON RIDGE® Elements



MATERIAL DETAIL



Woodgrain Classic surface texture on base steel and composite overlay.

COLOR OPTIONS



WINDOW OPTIONS

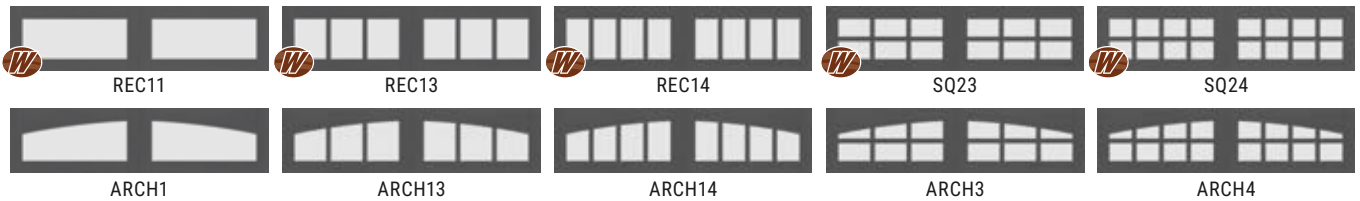

Window grilles are Woodgrain Classic texture. Insulated glass not available. Windows not available on Designs 31, 32, 33, 34, 35, 36 and 38.

Standard windows available on the following widths only: 8'0", 9'0", 10'0", 12'0", 13'0", 13'6", 16'0", 17'0", 18'0".

Impact rated windows available on the following widths only: 8'0", 9'0", 10'0", 12'2", 16'2", 18'2". To view additional designs, windows and top sections available, please visit www.clopaydoor.com.

Impact rated windows available.

SPECIALTY GLASS OPTIONS

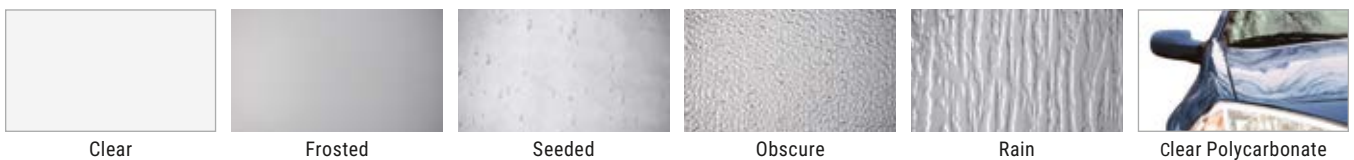

Impact rated windows are available in clear polycarbonate and may have a wavy appearance.

CANYON RIDGE® Chevron

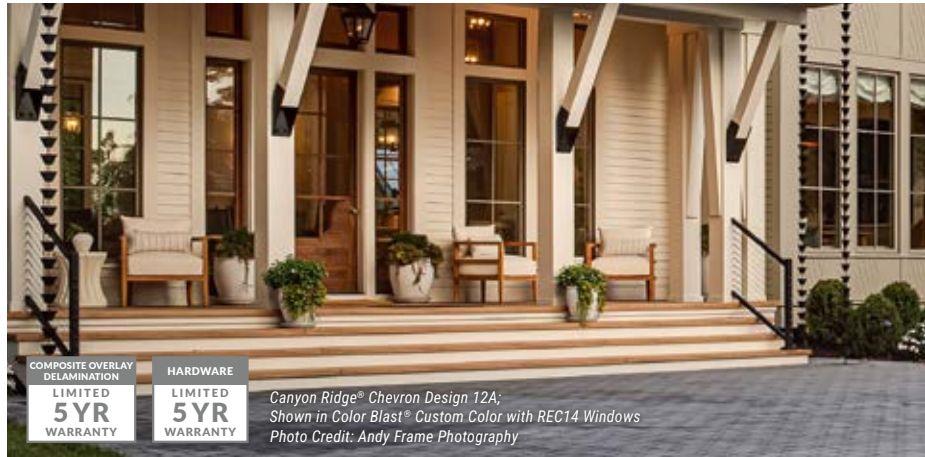

Chevron patterns have a modern, geometric feel for a timeless door that adds a hint of old-world charm and character to your home's exterior. Choose from four designs of diagonally placed planks constructed in low-maintenance faux wood composite cladding that looks and feels like real wood.

STYLE AND CONSTRUCTION

- 5-layer construction, 2" thick Intellicore® polyurethane insulation (R-value 20.4).
- Attractive beveled edge, clip-in grilles are removable for easy cleaning.
- Replaceable vinyl bottom weatherseal in a corrosion-resistant retainer helps seal out the elements.
- 10-ball nylon rollers for quiet operation.
- Heavy-duty 14 gauge steel hinges for long-lasting performance.

Calculated door section R-value is in accordance with DASMA TDS-163.

DOOR DESIGNS

Custom designs available, contact Clopay for availability.

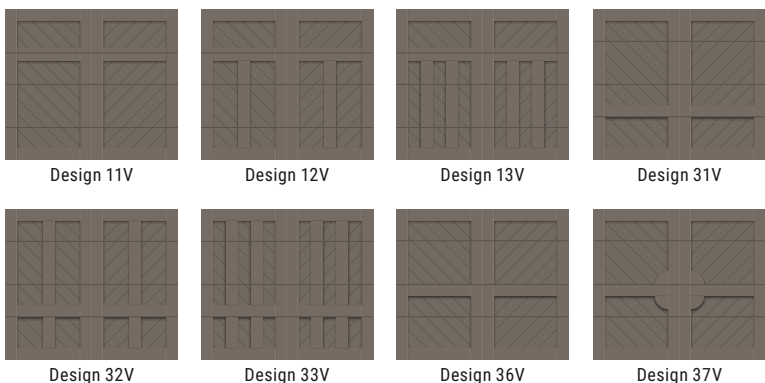

Doors shown in Bronze Finish with Mahogany cladding and Mahogany overlays.

CLADDING DESIGN OPTIONS

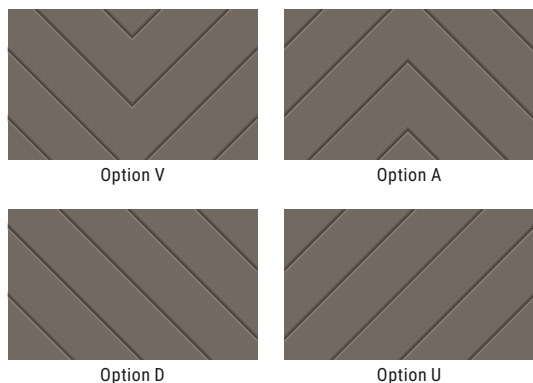

WINDCODE® AVAILABILITY CHART								
Common Door Widths	W1	W3	W4	W5	W6	W7	W8	
Model CAN	8', 9' Wide Door	S +13/-15 PSF	SELECT W4	FS +28/-29 PSF	FS +30/-32 PSF	FTDWS +38/-44 PSF	SELECT W8	FDW +54/-60 PSF
	10', 12' Wide Door	S +12.5/-14 PSF	SELECT W4	FS +25.5/-25.5 PSF	FS +30/-30 PSF	TAPERED STRUT FTDWS +38/-42 PSF	SELECT W8	TAPERED STRUT FDW +46/-52 PSF
	16' Wide Door	S +12.5/-14 PSF	SELECT W4	FS +25.5/-25.5 PSF	FS +30/-30 PSF	TAPERED STRUT FTDWS +38/-42 PSF	SELECT W8	TAPERED STRUT FDW +46/-52 PSF
	18' Wide Door	S +12.5/-14 PSF	SELECT W4	F +25/-25 PSF	SELECT W6	TAPERED STRUT FTDWS +38/-42 PSF		
S Standard Windows Available I Impact Rated		W Patented Impact Windows Available F Florida Approved			D Dade County Approved T Texas Department of Insurance Approved			

For W6 - W8 doors over 10'2" wide, add 2" to the door width.

CANYON RIDGE® Chevron



MATERIAL DESIGN OPTIONS

CLADDING MATERIALS



Clear Cypress



Mahogany



Clear Cypress



Pecky Cypress



Mahogany

Cladding and overlay material options may be mixed and matched.

FINISHING AND CARE: Proper care and maintenance are imperative for long-term performance and appearance of Canyon Ridge® garage doors. Periodic inspection and maintenance of the composite cladding and overlays are required. Complete finishing and maintenance instructions are provided with the door and are also available from your Clopay Dealer or online at www.clopaydoor.com.

COLOR OPTIONS



Medium Finish



Dark Finish



Walnut Finish



Slate Finish



Bronze Finish*



Charcoal Finish*



Black Finish*



White Finish*



Primed
(No Finish)

*Bronze, Charcoal, Black and White Finish available only on Mahogany cladding and overlays.

Two-tone doors are available. To see all available options go to: dis.clopay.com.

Doors can be ordered primed for those homeowners wishing to custom paint or stain their doors. Door stain color will vary slightly within a door due to the finishing process. Due to the printing process, colors may vary.

WINDOW OPTIONS



REC11



REC13



REC14



SQ23



SQ24



ARCH1



ARCH13



ARCH14



ARCH3



ARCH4

Window grilles are Mahogany texture. Windows not available on Designs 31, 32, 33, 36 and 37. Double door designs also available.

Standard windows available on the following widths only: 6'2", 8'0", 9'0", 10'0", 10'2", 12'0", 12'2", 13'6", 15'0", 15'2", 15'6", 15'8", 16'0", 16'2", 18'0", 18'2", 20'0", 20'2".

Impact rated windows available on the following widths only: 8'0", 9'0", 10'0", 12'2", 16'2", 18'2". To view additional designs, windows and top sections available, please visit www.clopaydoor.com.

 Impact rated windows available.

SPECIALTY GLASS OPTIONS

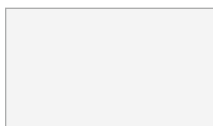

Clear

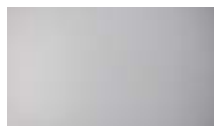

Frosted



Seeded



Obscure



Rain



Clear Polycarbonate

Windows are available insulated in clear, frosted, seeded, obscure and rain.

Impact rated windows are available in clear polycarbonate and may have a wavy appearance.

CANYON RIDGE® Louver

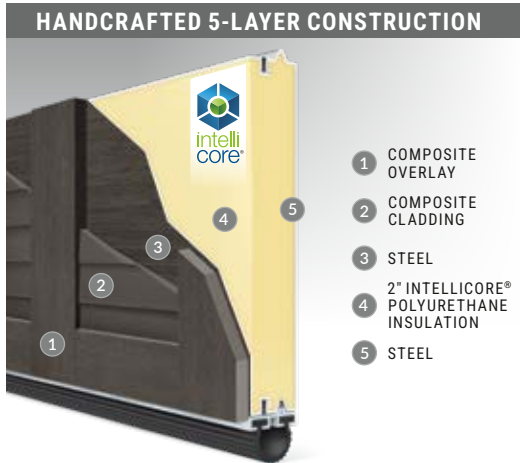

Versatile and unique, the plantation shutter style Canyon Ridge Louver garage doors are a perfect complement to coastal beach homes or colonial estates. They can also be a standout piece on traditional exteriors or modern farmhouses. Whatever your style, these doors add “wow” factor to your home.

STYLE AND CONSTRUCTION

- 5-layer construction, 2” thick Intellicore® polyurethane insulation (R-value 18.4–20.4).
- Attractive beveled edge, clip-in grilles are removable for easy cleaning.
- Replaceable vinyl bottom weatherseal in a corrosion-resistant retainer helps seal out the elements.
- 10-ball nylon rollers for quiet operation.
- Heavy-duty 14 gauge steel hinges for long-lasting performance.

Calculated door section R-value is in accordance with DASMA TDS-163.

DOOR DESIGNS

Custom designs available, contact Clopay for availability.

SERIES 4



SERIES 5



Doors shown in Slate Finish.

WINDCODE® AVAILABILITY CHART								
Common Door Widths	W1	W3	W4	W5	W6	W7	W8	
Model CAN	8', 9' Wide Door	S +13/-15 PSF	SELECT W4	FS +28/-29 PSF	FS +30/-32 PSF	☉ FTDWS +38/-44 PSF	SELECT W8	☉ F D W +54/-60 PSF
	10', 12' Wide Door	S +12.5/-14 PSF	SELECT W4	FS +25.5/-25.5 PSF	FS +30/-30 PSF	TAPERED STRUT ☉ FTDWS +38/-42 PSF	SELECT W8	TAPERED STRUT ☉ F D W +46/-52 PSF
	16' Wide Door	S +12.5/-14 PSF	SELECT W4	FS +25.5/-25.5 PSF	FS +30/-30 PSF	TAPERED STRUT ☉ FTDWS +38/-42 PSF	SELECT W8	TAPERED STRUT ☉ F D W +46/-52 PSF
	18' Wide Door	S +12.5/-14 PSF	SELECT W4	F +25/-25 PSF	SELECT W6	TAPERED STRUT ☉ FTDWS +38/-42 PSF		
S Standard Windows Available ☉ Impact Rated		W Patented Impact Windows Available F Florida Approved			D Dade County Approved T Texas Department of Insurance Approved			

For W6 – W8 doors over 10'2" wide, add 2" to the door width.

CANYON RIDGE® Louver



MATERIAL DESIGN OPTIONS

CLADDING/STEEL BASE MATERIAL



Louver Mahogany



Ultra-Grain® Finish Clear Cypress or Solid Color Steel

OVERLAY MATERIAL

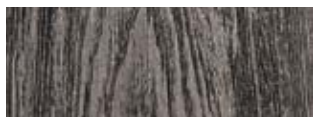

Clear Cypress



Mahogany

Cladding and overlay material options may be mixed and matched.

FINISHING AND CARE: Proper care and maintenance are imperative for long-term performance and appearance of Canyon Ridge® garage doors. Periodic inspection and maintenance of the composite cladding and overlays are required. Complete finishing and maintenance instructions are provided with the door and are also available from your Clopay Dealer or online at www.clopaydoor.com.

COLOR OPTIONS



Medium Finish Dark Finish* Walnut Finish Slate Finish Bronze Finish†



Charcoal Finish† Black Finish† White Finish† Primed (No Finish)

*Dark Finish not available as a base steel color on Designs 41, 42, 43, 44, 45, 46 and 47.

† Bronze, Charcoal, Black and White Finish available only on Mahogany cladding and overlays.

Two-tone doors are available. To see all available options go to: dis.clopay.com.

Steel surfaces have woodgrain texture.

Doors can be ordered primed for those homeowners wishing to custom paint or stain their doors.

Note: Primed solid steel base is a brown color. Door stain color will vary slightly within a door due to the finishing process. Due to the printing process, above colors may vary.

WINDOW OPTIONS

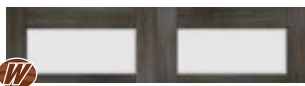

REC11

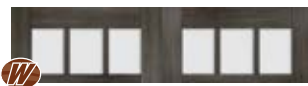

REC13



REC14



SQ23

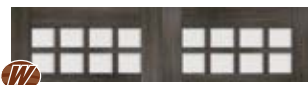

SQ24



Window grilles are Mahogany texture. Windows available only on Louver Design 52.

Standard windows available on the following widths only: 6'2", 8'0", 9'0", 10'0", 10'2", 12'0", 12'2", 13'6", 15'0", 15'2", 15'6", 15'8", 16'0", 16'2", 18'0", 18'2", 20'0", 20'2".

Impact rated windows available on the following widths only: 8'0", 9'0", 10'0", 12'2", 16'2", 18'2".

To view additional designs, windows and top sections available, please visit www.clopaydoor.com.



Impact rated windows available.



Design 52 with REC11 Windows

SPECIALTY GLASS OPTIONS

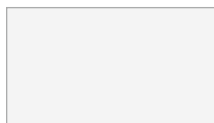

Clear

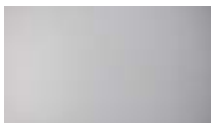

Frosted



Seeded



Obscure



Rain



Clear Polycarbonate

Windows are available insulated in clear, frosted, seeded, obscure and rain.

Impact rated windows are available in clear polycarbonate and may have a wavy appearance.

COACHMAN®

HANDCRAFTED 4-LAYER CONSTRUCTION



Coachman® garage doors give your home classic elegance while complementing your home's architectural style.

STYLE AND CONSTRUCTION

- Custom composite overlay with beveled, coped edge and center groove creates a detailed carriage house look, available in four colors.
- Model CGU has 2" thick Intellicore® polyurethane insulation (R-value 18.4).
- Model CG has 2" thick bonded polystyrene insulation (R-value 9.0).
- Model CD has 1-3/8" thick bonded polystyrene insulation (R-value 6.5).
- Insulated with a thermal break between two layers of bonded steel.
- Coachman® garage doors can be painted using a high-quality exterior latex paint.

IMPORTANT: For doors being painted black and very dark colors (having an LRV of 12 or less), please order Canyon Ridge® Carriage House 4-Layer in Black or primed. For colors having an LRV of 13 to 38 we require the use of tested and approved paints. A list of tested and approved paints can be found at: <http://info.garagedoors.com/lrv>.

DOOR DESIGNS

Custom designs available, contact Clopay for availability.



WINDCODE® AVAILABILITY CHART

Common Door Widths		W1	W3	W4	W5	W6	W7	W8
Model CD	8', 9' Wide Door	S +13/-15 PSF	SELECT W5	SELECT W5	FTS +33/-37 PSF			
	10', 12' Wide Door	S +12.5/-14 PSF	SELECT W4	FTS +25/-25 PSF				
	16' Wide Door	S +12.5/-14 PSF	SELECT W4	FTS +25/-25 PSF				
	18' Wide Door	S +12.5/-14 PSF						
Model CG	8', 9' Wide Door	S +13/-15 PSF	SELECT W6	SELECT W6	SELECT W6	FTS +38/-42 PSF	SELECT W8	FT +54/-60 PSF
	10', 12' Wide Door	S +12.5/-14 PSF	SELECT W5	SELECT W5	FTS +30/-30 PSF	FT +37/-40 PSF	SELECT W8	FT +46/-52 PSF
	16' Wide Door	S +12.5/-14 PSF	SELECT W5	SELECT W5	FTS +30/-30 PSF	FT +37/-40 PSF	SELECT W8	FT +46/-52 PSF
	18' Wide Door	S +12.5/-14 PSF	SELECT W6	SELECT W6	SELECT W6	FT +38/-42 PSF		

For W1, Model CG is not available.

For W6 - W8 doors over 10'2" wide, add 2" to the door width.

COACHMAN®



COLOR OPTIONS



Standard White Almond Desert Tan Sandtone

Overlay and base colors can be mixed to achieve desired look. Interior steel is always Standard White. Due to the printing process, colors may vary.

SPECIALTY GLASS OPTIONS



Clear Frosted Seeded Obscure Rain

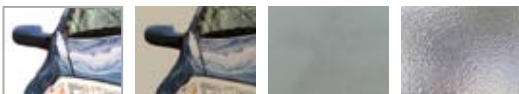

Clear Polycarbonate Bronze Polycarbonate Matte Polycarbonate Pebble Polycarbonate

Windows are available single pane or insulated in clear, frosted, seeded, obscure and rain designs. Impact rated windows are available in clear, bronze, matte and pebble polycarbonate and may have a wavy appearance. Additional charges of optional glass apply.

WINDOW OPTIONS

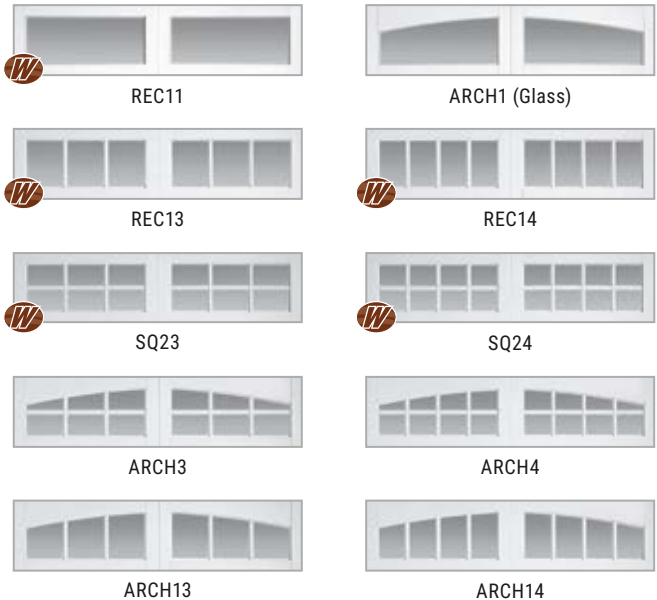

Series 3 and 4 are not available with windows. Double door designs also available.

Impact rated windows available.

WINDCODE® AVAILABILITY CHART

Common Door Widths		W1	W3	W4	W5	W6	W7	W8
Model CGU	8', 9' Wide Door	S +13/-15 PSF	SELECT W4	S +28/-29 PSF	SELECT W6	FT DWS +38/-44 PSF	SELECT W8	FDW +54/-60 PSF
	10' Wide Door	S +12.5/-14 PSF	SELECT W4	S +25/-25 PSF	S +30/-30 PSF	TAPERED STRUT FT DWS +38/-42 PSF	SELECT W8	TAPERED STRUT FD +46/-52 PSF
	12' Wide Door	S +12.5/-14 PSF	SELECT W4	S +25/-25 PSF	S +30/-30 PSF	TAPERED STRUT FT DWS +38/-42 PSF	SELECT W8	TAPERED STRUT FDW +46/-52 PSF
	16' Wide Door	S +12.5/-14 PSF	SELECT W4	S +25/-25 PSF	S +30/-30 PSF	TAPERED STRUT FT DWS +38/-42 PSF	SELECT W8	TAPERED STRUT FDW +46/-52 PSF
	18' Wide Door	S +12.5/-14 PSF	SELECT W4	S +25/-25 PSF	SELECT W6	TAPERED STRUT FT DWS +38/-42 PSF		

S Standard Windows Available
 Impact Rated

W Patented Impact Windows Available
F Florida Approved

D Dade County Approved
T Texas Department of Insurance Approved

For W6-W8 doors over 10'2" wide, add 2" to the door width.

AVANTE®



Avante® is the perfect choice to modernize any home.

STYLE AND CONSTRUCTION

- 2-1/8" aluminum frame provides a virtually maintenance-free, long-lasting door.
- Intellicore® polyurethane insulated rails and stiles (Model AXU).
- R-value 3.8/U-factor 0.86 (Model AXU when glazed with clear insulated glass).
- Many glass and panel options available.
- Section joint seal helps keep out air and water.
- Integral reinforcing fin provides increased strength and longevity (Available on double car models).
- Heavy-duty steel ball bearing rollers with nylon tires provide quiet operation.

Calculated door section R-value is in accordance with DASMA TDS-163.

DOOR DESIGNS

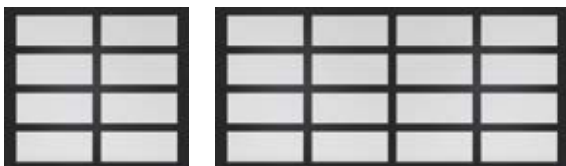

Additional sizes available for commercial door configurations. Contact Clopay for details.

HARDWARE



Attractive color-matched aluminum grip handles.

WINDCODE® AVAILABILITY CHART

Common Door Widths	W1	W2	W3	W4	W5	W6	W8	
Model AX/AXU	8', 9', 10' Wide Door	S +14/-14 PSF	S +18/-20 PSF	SELECT W4	FS +25/-25 PSF	FS +30/-30 PSF	FS +40/-44 PSF	FDS +52/-58 PSF
	12' Wide Door	S +14/-14 PSF	S +18/-20 PSF	SELECT W4	FS +25/-25 PSF	FS +32/-32 PSF	FS +40/-44 PSF	FDS +52/-58 PSF
	14' Wide Door	S +14/-14 PSF	S +18/-20 PSF	SELECT W4	FS +25/-25 PSF	FS +32/-32 PSF	FS +40/-44 PSF	FDS +52/-58 PSF
	16' Wide Door	S +14/-14 PSF	S +18/-20 PSF	SELECT W4	FS +25/-25 PSF	FS +32/-32 PSF	FS +40/-42 PSF	FDS +46/-52 PSF
	18' Wide Door	S +14/-14 PSF	S +18/-20 PSF	SELECT W4	FS +25/-25 PSF	FS* +30/-30 PSF	FS* +36/-40 PSF	AVAILABILITY PENDING
	20' Wide Door	S +14/-14 PSF	S +18/-20 PSF	SELECT W4	FS* +25/-25 PSF	FS* +30/-30 PSF	FS* +36/-40 PSF	

S Standard Windows Available **W** Impact Windows Available **D** Dade County Approved **W** Impact Rated **F** Florida Approved
T Texas Department of Insurance Approved *Doors require additional center stiles/more windows per section compared to standard doors

*Glass may be obscured with reinforcement on 18' wide doors.
W8 only available with 5/16" clear laminate impact rated glass. See your Clopay Dealer for details.*



FRAME/SOLID PANEL COLOR OPTIONS



Due to the anodizing process, color variation may occur. The use of "Bronze (Painted)" is recommended for a more consistent bronze finish color. Custom colors available.

GLASS/PANEL OPTIONS

Additional glass options available. Glass options affect price.

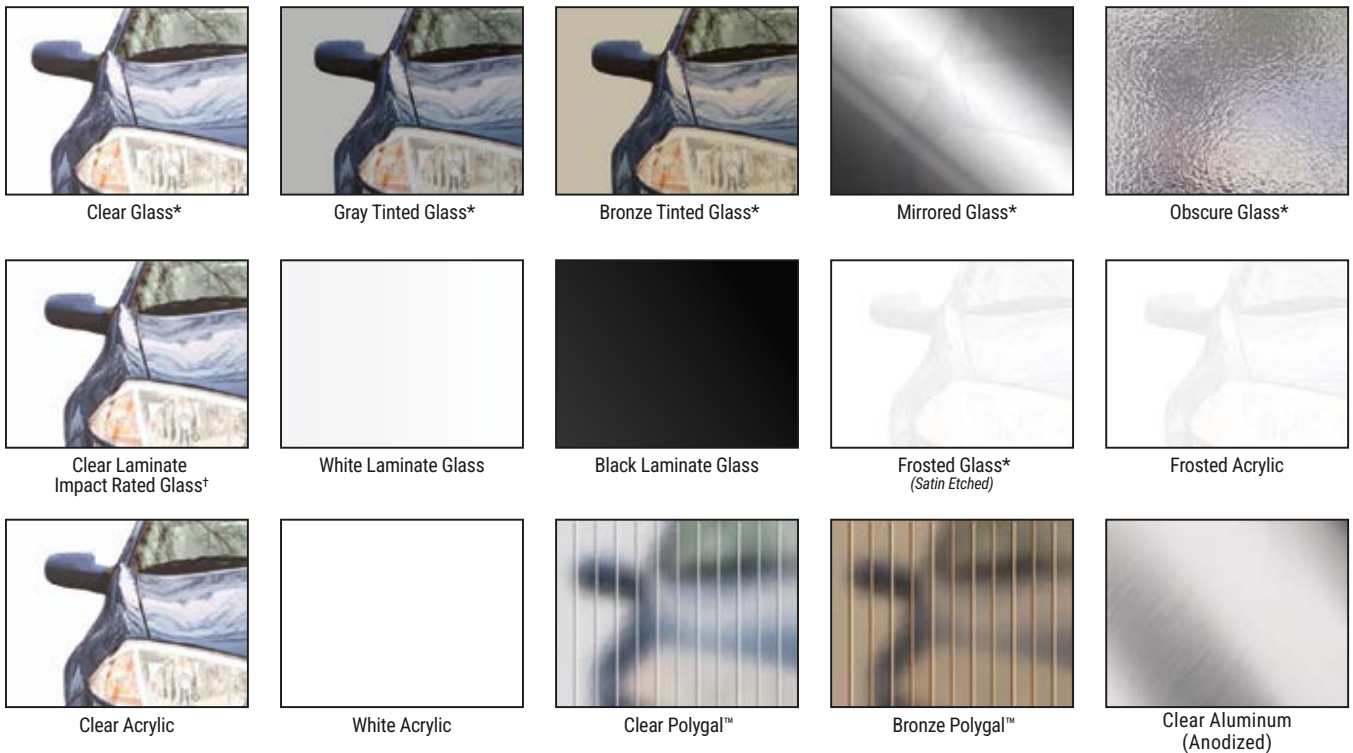

*Glass is tempered.

†5/16" clear, white, gray and bronze laminate impact rated glass is available only on AXUW8/AXW8.

Glass available in single pane or insulated. Laminated and mirrored glass not available insulated. Panels can be aluminum to match the aluminum frame. Glass/acrylic panels may be combined with aluminum panels. Custom glass and colors available. See your Clopay Dealer for details. Acrylic windows require special cleaning. See care and maintenance manual.

VERTISTACK®

AVANTE®



Connect to the outdoors with our VertiStack® Avante® modern aluminum and glass garage door. The unique, compact design stacks sections vertically on the wall above the opening, eliminating the need for exposed hinges, cable or overhead track for a crisp, clean look. Closed, the glass panel door lets in daylight and outdoor views. When opened, the interior footprint extends outside, creating an easy flow during gatherings.

STYLE AND CONSTRUCTION

- 2-1/8" aluminum frame provides a virtually maintenance-free, long-lasting door.
- Intellicore® polyurethane insulated rails and stiles (Model VSAXU).
- Section joint seal helps keep out air and water.
- Heavy-duty steel ball bearing rollers with nylon tires provide quiet operation.

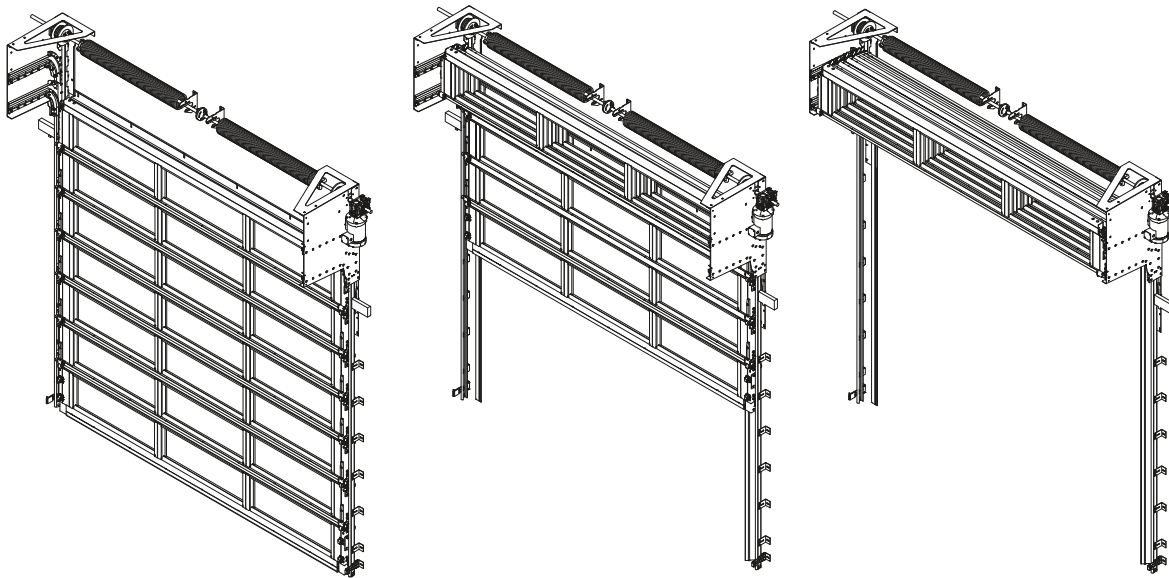

The stacked sections require minimal projection off of the wall, so the door doesn't interfere with mechanical, electrical or plumbing fixtures, leaving room for fans, lighting, overhead storage or extended height ceilings. The sections can even be recessed into a ceiling soffit so when the door is open, no one will know it's there.

WINDCODE® AVAILABILITY CHART									
Common Door Widths	W1	W2	W3	W4	W5	W6	W8		
VSAX	14' Wide Door	SELECT W4	SELECT W4	SELECT W4	S +25/-25 PSF				
S Standard Windows Available		W Impact Windows Available		D Dade County Approved		W Impact Rated		F Florida Approved	
T Texas Department of Insurance Approved		*Doors require additional center stiles/more windows per section compared to standard doors							

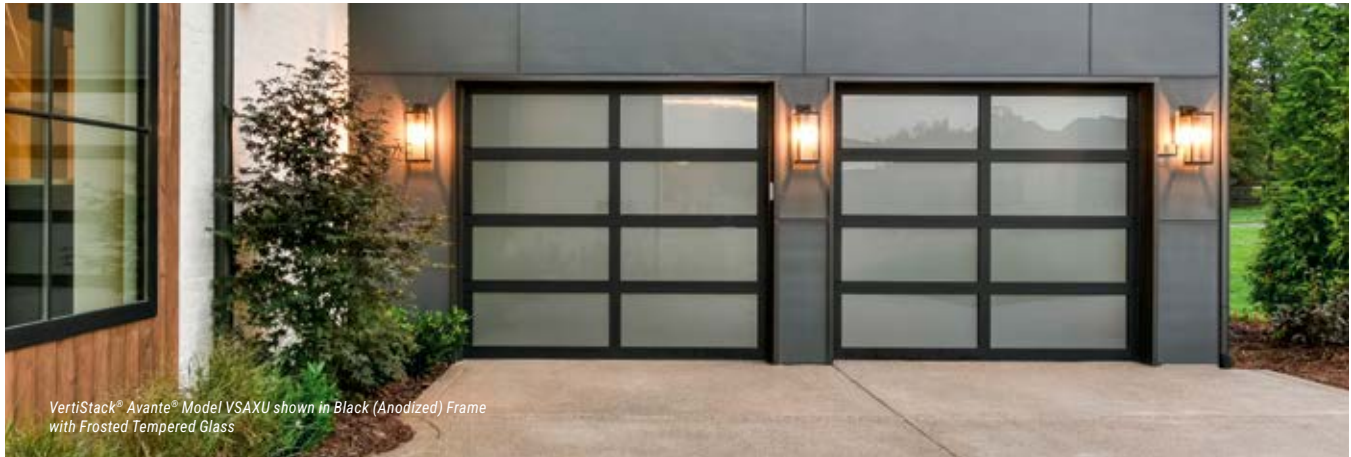

VertiStack® Avante® Model VSAXU shown in Black (Anodized) Frame with Frosted Tempered Glass

DOOR DESIGNS

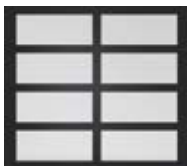

AX/AXU
(Single car door)

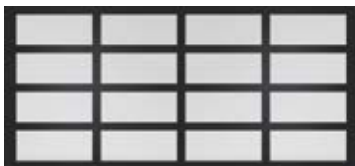

AX/AXU
(Double car door)

Additional sizes available for commercial door configurations. Contact Clopay for details.

FRAME/SOLID PANEL COLOR OPTIONS



Clear Aluminum (Anodized)

Standard White (Painted)

Bronze (Painted)

Chocolate (Painted)

Bronze (Anodized)

Black (Anodized)

Dark Bronze (Anodized)

Due to the anodizing process, color variation may occur. The use of "Bronze (Painted)" is recommended for a more consistent bronze finish color. Custom colors available.

GLASS/PANEL OPTIONS

Additional glass options available. Glass options affect price.



Clear Glass*



Gray Tinted Glass*



Bronze Tinted Glass*



Mirrored Glass*



Obscure Glass*



Clear Laminate Impact Rated Glass†



White Laminate Glass

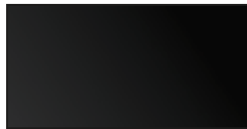

Black Laminate Glass



Frosted Glass* (Satin Etched)



Frosted Acrylic



Clear Acrylic



White Acrylic

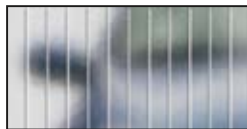

Clear Polygal™

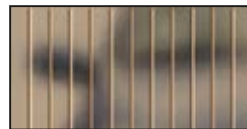

Bronze Polygal™



Clear Aluminum (Anodized)

*Glass is tempered.

†5/16" clear, white, gray and bronze laminate impact rated glass is available only on AXUW8/AXW8.

Glass available in single pane or insulated. Laminated and mirrored glass not available insulated. Panels can be aluminum to match the aluminum frame. Glass/acrylic panels may be combined with aluminum panels. Custom glass and colors available. See your Clopay Dealer for details. Acrylic windows require special cleaning. See care and maintenance manual.

AVANTE® SLEEK



Avante® Sleek features slim horizontal glass windows and minimal vertical stiles for broad unobstructed views.

STYLE AND CONSTRUCTION

- 2-1/8" aluminum frame provides a virtually maintenance-free, long-lasting door.
- Intellicore® polyurethane insulated rails and stiles (Model AZ6U).
- Many glass options available.
- Section joint seal helps keep out air and water.
- Integral reinforcing fin provides increased strength and longevity (Available on double car models).
- Heavy-duty steel ball bearing rollers with nylon tires provide quiet operation.

Calculated door section R-value is in accordance with DASMA TDS-163.

DOOR DESIGNS



AZ6/AZ6U
(Single car door)

AZ6/AZ6U
(Double car door)

Additional sizes available for commercial door configurations. Contact Clopay for details.

HARDWARE



Attractive color-matched aluminum grip handles.

WINDCODE® AVAILABILITY CHART							
Common Door Widths	W1	W2	W3	W4	W5	W6	W8
Model AZ6/AZ6U	8', 9', 10' Wide Door	S +14/-14 PSF	S +18/-20 PSF	SELECT W4	S +25/-25 PSF	S +32/-32 PSF	
	12' Wide Door	S +14/-14 PSF	S +18/-20 PSF	SELECT W4	S +25/-25 PSF	S +32/-32 PSF	
	14' Wide Door	S +14/-14 PSF	S +18/-20 PSF	SELECT W4	S +25/-25 PSF	S +32/-32 PSF	
	16' Wide Door	S +14/-14 PSF	S +18/-20 PSF	SELECT W4	S +25/-25 PSF	S +32/-32 PSF	
	18' Wide Door	S +14/-14 PSF	S +18/-20 PSF				
	20' Wide Door	S +14/-14 PSF	S +18/-20 PSF				

S Standard Windows Available **W** Impact Windows Available **D** Dade County Approved **W** Impact Rated **F** Florida Approved
T Texas Department of Insurance Approved *Doors require additional center stiles/more windows per section compared to standard doors

Glass may be obscured with reinforcement on 18' wide doors.



FRAME COLOR OPTIONS



Due to the anodizing process, color variation may occur. The use of "Bronze (Painted)" is recommended for a more consistent bronze finish color. Custom colors available.

GLASS OPTIONS

NOTE: Glass options affect price.

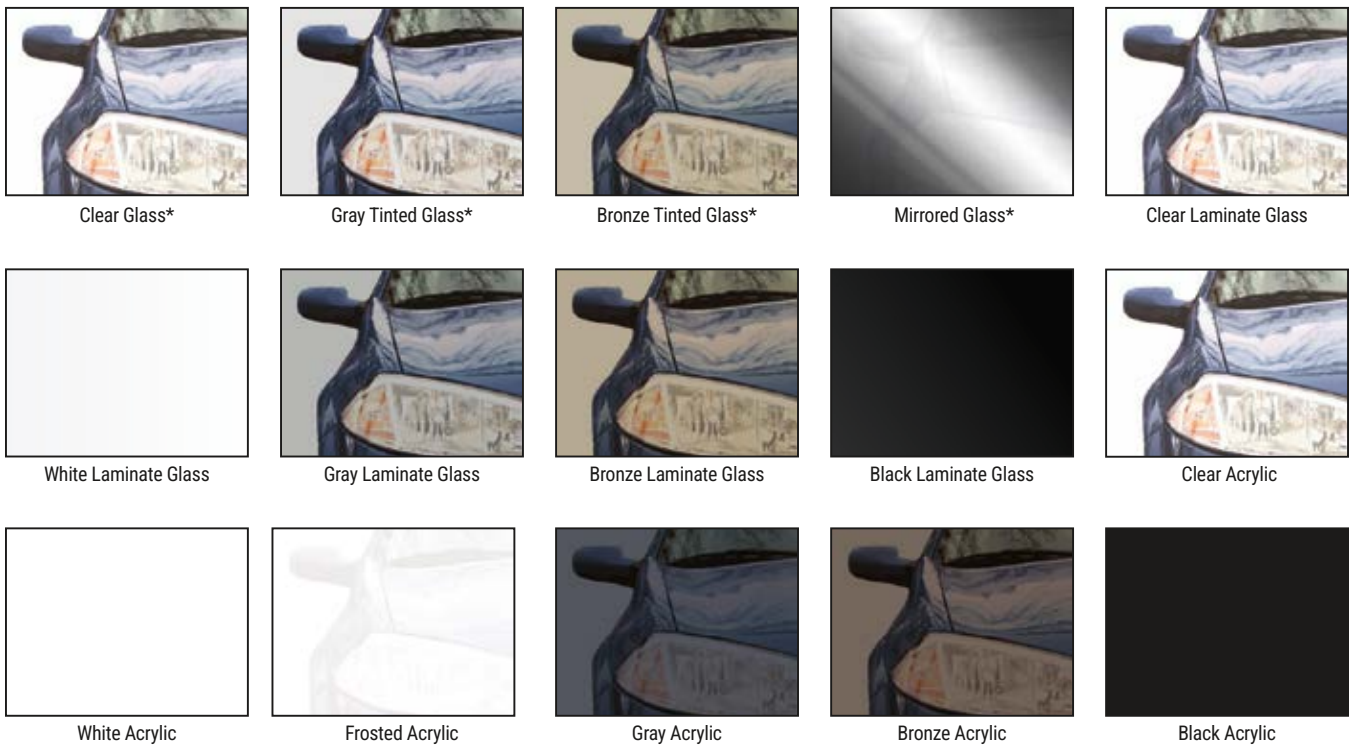

*Glass is tempered.

Glass available in single pane or insulated. Laminated and mirrored glass not available insulated. Custom glass and colors available. See your Clopay Dealer for details. Acrylic windows require special cleaning. See care and maintenance manual.

GALLERY® STEEL

HANDCRAFTED 3, 2 OR 1-LAYER CONSTRUCTION



Constructed of durable steel, this vintage style line is available in long or short grooved panel designs with various windows, colors and hardware options to create that one-of-a-kind look.

STYLE AND CONSTRUCTION

- Hot-dipped galvanized steel skin with a baked-on primer and top coat helps ensure durability and long-lasting beauty.
- Intellicore® polyurethane or bonded polystyrene insulation with R-values ranging from 18.4 to 6.3.
- Windows are standard with double strength clear glass and have optional snap-in grilles. Other glass options are available; see opposite page for available options.
- Section joints and bottom weatherseal in a corrosion-resistant retainer help seal out the elements.

Calculated door section R-value is in accordance with DASMA TDS-163.

PANEL OPTIONS



Short Panel



Long Panel

COLOR OPTIONS



*Not available on all models. Complete color availability can be found on pages 50-51.

†Additional charges apply.

Ultra-Grain® finish is a faux woodgrain paint coating offering the beauty of stained wood without the upkeep.

Ultra Grain® finish doors will have either a stucco or woodgrain steel surface texture.

PANEL DETAIL

Deep-embossed panels with woodgrain or stucco surface texture improve appearance close-up and from the curb.



MODEL SPECIFICATIONS

MODEL	GD2SU	GD2LU	GD1SU	GD1LU	GD2SP	GD2LP	GD1SP	GD1LP
Panel Style	Short	Long	Short	Long	Short	Long	Short	Long
Insulation	2" Intellicore® Polyurethane	2" Intellicore® Polyurethane	1-3/8" Intellicore® Polyurethane	1-3/8" Intellicore® Polyurethane	2" Bonded Polystyrene	2" Bonded Polystyrene	1-3/8" Bonded Polystyrene	1-3/8" Bonded Polystyrene
Construction	3-Layer	3-Layer	3-Layer	3-Layer	3-Layer	3-Layer	3-Layer	3-Layer
R-value	18.4	18.4	12.9	12.9	9.0	9.0	6.5	6.5

GALLERY® STEEL



WINDOW OPTIONS

GLASS



Additional double width door designs available.
 Double strength glass is standard.
 Long windows are available on short panel doors and short windows are available on long panel doors.
 Some limitations may apply based on W-Level. Contact your Clopay Dealer for details.

ACRYLIC



Acrylic windows require special cleaning. See care and maintenance manual.

Impact rated windows available (Mocha Brown is not available on impact rated windows)

SPECIALTY GLASS OPTIONS



Windows are available single pane or insulated in clear, frosted, seeded, obscure and rain designs.
 Impact rated windows are available in clear, bronze, matte and pebble polycarbonate and may have a wavy appearance. Additional charges of optional glass apply.

MODEL SPECIFICATIONS

MODEL	GD4S	GD4L	GD4SV	GD4LV	GD5S	GD5SV
Panel Style	Short	Long	Short	Long	Short	Short
Insulation	Non-Insulated	Non-Insulated	Polystyrene	Polystyrene	Non-Insulated	Polystyrene
Construction	1-Layer	1-Layer	2-Layer	2-Layer	1-Layer	2-Layer
R-value	N/A	N/A	6.3	6.3	N/A	6.3

GALLERY® STEEL

WINDCODE® AVAILABILITY CHART

Common Door Widths	W1	W3	W4	W5	W6	W7	W8	
Model GD2SU	8', 9' Wide Door	S +13/-15 PSF	SELECT W4	FS +28/-29 PSF	SELECT W6	FTWS +38/-44 PSF	SELECT W8	FW +54/-60 PSF
	10', 12' Wide Door	S +12.5/-14 PSF	SELECT W4	FS +25.5/-25.5 PSF	FS +30/-30 PSF	TAPERED STRUT FTWS +38/-42 PSF	SELECT W8	TAPERED STRUT FW +46/-52 PSF
	16' Wide Door	S +12.5/-14 PSF	SELECT W4	FS +25.5/-25.5 PSF	FS +30/-30 PSF	TAPERED STRUT FTWS +38/-42 PSF	SELECT W8	TAPERED STRUT FW +46/-52 PSF
	18' Wide Door	S +12.5/-14 PSF	SELECT W4	F +25/-25 PSF	SELECT W6	TAPERED STRUT FTWS +38/-42 PSF		
Model GD2LU	8', 9' Wide Door	S +13/-15 PSF	SELECT W4	FS +28/-29 PSF	SELECT W6	FTWS +38/-44 PSF	SELECT W8	FW +54/-60 PSF
	10', 12' Wide Door	S +12.5/-14 PSF	SELECT W4	FS +25.5/-25.5 PSF	FS +30/-30 PSF	TAPERED STRUT FTWS +38/-42 PSF	SELECT W8	TAPERED STRUT FW +46/-52 PSF
	16' Wide Door	S +12.5/-14 PSF	SELECT W4	FS +25.5/-25.5 PSF	FS +30/-30 PSF	TAPERED STRUT FTWS +38/-42 PSF	SELECT W8	TAPERED STRUT FW +46/-52 PSF
	18' Wide Door	S +12.5/-14 PSF	SELECT W4	F +25/-25 PSF	SELECT W6	TAPERED STRUT FTWS +38/-42 PSF		
Model GD1SU	8', 9' Wide Door	S +13/-15 PSF	FS +20/-21 PSF	SELECT W5	S +30/-32 PSF			
	10', 12' Wide Door	S +12.5/-14 PSF	FS +20/-21 PSF	SELECT W5	F +30/-30 PSF			
	16' Wide Door	S +12.5/-14 PSF	FS +20/-21 PSF	SELECT W5	F +30/-30 PSF			
	18' Wide Door	S +12.5/-14 PSF						
Model GD1LU	8', 9' Wide Door	S +13/-15 PSF	FS +20/-21 PSF	SELECT W5	S +30/-32 PSF			
	10', 12' Wide Door	S +12.5/-14 PSF	FS +20/-21 PSF	SELECT W5	F +30/-30 PSF			
	16' Wide Door	S +12.5/-14 PSF	FS +20/-21 PSF	SELECT W5	F +30/-30 PSF			
	18' Wide Door	S +12.5/-14 PSF						
Model GD2SP	8', 9' Wide Door	S +13/-15 PSF	SELECT W4	FS +28/-29 PSF	SELECT W6	FTWS +38/-44 PSF	SELECT W8	FDW +54/-60 PSF
	10', 12' Wide Door	S +12.5/-14 PSF	SELECT W4	FS +25.5/-25.5 PSF	FS +30/-30 PSF	TAPERED STRUT FTDWS +38/-42 PSF	SELECT W8	TAPERED STRUT FDW +46/-52 PSF
	16' Wide Door	S +12.5/-14 PSF	SELECT W4	FS +25.5/-25.5 PSF	FS +30/-30 PSF	TAPERED STRUT FTDWS +38/-42 PSF	SELECT W8	TAPERED STRUT FDW +46/-52 PSF
	18' Wide Door	S +12.5/-14 PSF	SELECT W4	F +25/-25 PSF	SELECT W6	TAPERED STRUT FTDWS +38/-42 PSF		
	20'2" Wide Door	SELECT W5	SELECT W5	SELECT W5	FS +30/-33 PSF			
Model GD2LP	8', 9' Wide Door	S +13/-15 PSF	SELECT W4	FS +28/-29 PSF	SELECT W6	FTWS +38/-44 PSF	SELECT W8	FDW +54/-60 PSF
	10', 12' Wide Door	S +12.5/-14 PSF	SELECT W4	FS +25.5/-25.5 PSF	FS +30/-30 PSF	TAPERED STRUT FTDWS +38/-42 PSF	SELECT W8	TAPERED STRUT FDW +46/-52 PSF
	16' Wide Door	S +12.5/-14 PSF	SELECT W4	FS +25.5/-25.5 PSF	FS +30/-30 PSF	TAPERED STRUT FTDWS +38/-42 PSF	SELECT W8	TAPERED STRUT FDW +46/-52 PSF
	18' Wide Door	S +12.5/-14 PSF	SELECT W4	F +25/-25 PSF	SELECT W6	TAPERED STRUT FTDWS +38/-42 PSF		
	20'2" Wide Door	SELECT W5	SELECT W5	SELECT W5	FS +30/-33 PSF			
Model GD1SP	8', 9' Wide Door	S +13/-15 PSF	FS +20/-21 PSF	SELECT W5	FS +30/-32 PSF			
	10', 12' Wide Door	S +12.5/-14 PSF	FS +20/-21 PSF	SELECT W5	F +30/-30 PSF			
	16' Wide Door	S +12.5/-14 PSF	FS +20/-21 PSF	SELECT W5	F +30/-30 PSF			
	18' Wide Door	S +12.5/-14 PSF						
Model GD1LP	8', 9' Wide Door	S +13/-15 PSF	FS +20/-21 PSF	SELECT W5	FS +30/-32 PSF			
	10', 12' Wide Door	S +12.5/-14 PSF	FS +20/-21 PSF	SELECT W5	F +30/-30 PSF			
	16' Wide Door	S +12.5/-14 PSF	FS +20/-21 PSF	SELECT W5	F +30/-30 PSF			
	18' Wide Door	S +12.5/-14 PSF						

GALLERY® STEEL

WINDCODE® AVAILABILITY CHART

Common Door Widths	W1	W3	W4	W5	W6	W7	W8	
GD4S 24 Gauge Pan Short	8', 9' Wide Door	S +13/-15 PSF	SELECT W4	FTS +25/-25 PSF	FTS +30/-32 PSF	FTW+ S* +38/-44 PSF	SELECT W8	FDW +50/-58 PSF
	10', 12' Wide Door	S +12.5/-14 PSF	SELECT W4	FTS* +25/-25 PSF	FTS* +30/-30 PSF	TAPERED STRUT FWS* +38/-42 PSF	SELECT W8	FDW +46/-52 PSF
	16' Wide Door	S +12.5/-14 PSF	SELECT W4	FTS* +25/-25 PSF	FTS* +30/-30 PSF	TAPERED STRUT FWS* +38/-42 PSF	SELECT W8	FDW +46/-52 PSF
	18' Wide Door	S* +12.5/-14 PSF	SELECT W4	FTS* +25/-25 PSF	SELECT W6	FS* +37/-39 PSF		
GD4SV 24 Gauge Insulated Short	8', 9' Wide Door	S +13/-15 PSF	SELECT W4	FTS +25/-25 PSF	FTS +30/-32 PSF			
	10', 12' Wide Door	S +12.5/-14 PSF	SELECT W4	FTS* +25/-25 PSF	FTS* +30/-30 PSF			
	16' Wide Door	S +12.5/-14 PSF	SELECT W4	FTS* +25/-25 PSF	FTS* +30/-30 PSF			
	18' Wide Door	S* +12.5/-14 PSF	SELECT W4	FTS* +25/-25 PSF				
GD4L 24 Gauge Pan Long	8', 9' Wide Door	S +13/-15 PSF	SELECT W4	FTS +25/-25 PSF	SELECT W6	FTW+ S* +38/-44 PSF		
	10', 12' Wide Door	S +12.5/-14 PSF	SELECT W4	FTS* +25/-25 PSF	SELECT W6	TAPERED STRUT FS* +38/-42 PSF		
	16' Wide Door	S +12.5/-14 PSF	SELECT W4	FTS* +25/-25 PSF	SELECT W6	TAPERED STRUT FS* +38/-42 PSF		
	18' Wide Door	S* +12.5/-14 PSF	SELECT W4	FTS* +25/-25 PSF				
GD4LY 24 Gauge Insulated Long	8', 9' Wide Door	S +13/-15 PSF	SELECT W4	FTS +25/-25 PSF				
	10', 12' Wide Door	S +12.5/-14 PSF						
	16' Wide Door	S +12.5/-14 PSF						
	18' Wide Door							
GD5S 25 Gauge Pan Short	8', 9' Wide Door	S +13/-15 PSF	SELECT W4	FS +25/-32 PSF	FS +30/-32 PSF	FS* +38/-42 PSF	F +42/-48 PSF	
	10', 12' Wide Door	S +12.5/-14 PSF	SELECT W4	FS* +24/-24.5 PSF	GD5S FS* +30/-30 or +32/-32 PSF	TAPERED STRUT GD5SSP F* +32/-37 PSF	TAPERED STRUT FS* +36/-42 PSF	
	16' Wide Door	S +12.5/-14 PSF	SELECT W4	FS* +24/-24.5 PSF	GD5S FS* +30/-30 or +32/-32 PSF	TAPERED STRUT GD5SSP F* +32/-37 PSF	TAPERED STRUT FS* +36/-42 PSF	
	18' Wide Door	S* +12.5/-14 PSF	SELECT W4	FS* +25/-27 PSF	SELECT W6	TAPERED STRUT FS* +36/-42 PSF		
GD5SV 25 Gauge Insulated Short	8', 9' Wide Door	S +13/-15 PSF	SELECT W4	FS +25/-32 PSF	FS +30/-32 PSF			
	10', 12' Wide Door	S +12.5/-14 PSF	SELECT W4	FS* +24/-24.5 PSF	GD5SV FS* +30/-30 or +32/-32 PSF	TAPERED STRUT GD5SPV F* +32/-37 PSF		
	16' Wide Door	S +12.5/-14 PSF	SELECT W4	FS* +24/-24.5 PSF	GD5SV FS* +30/-30 or +32/-32 PSF	TAPERED STRUT GD5SPV F* +32/-37 PSF		
	18' Wide Door	S* +12.5/-14 PSF	SELECT W4	FS* +25/-27 PSF				

S Standard Windows Available
 Impact Rated

W Patented Impact Windows Available
F Florida Approved

D Dade County Approved
T Texas Department of Insurance Approved

For W6 - W8 doors over 9' wide, add 2" to the door width.
For W6, Model GD4S 18' wide doors are available only at 7' high.
Standard windows are not available in Texas.

*Long window availability is limited due to reinforcement requirements.
†Impact windows are not available in Texas.

BRIDGEPORT™ STEEL



Bridgeport™ Steel garage doors combine the traditional symmetry of wood stile and rail door designs without the upkeep and maintenance. Create a look that complements the overall look of your home by selecting the window design, color and decorative hardware to give it that one-of-a-kind look.

STYLE AND CONSTRUCTION

- Hot-dipped galvanized steel skin with a baked-on primer and top coat helps ensure durability and long-lasting beauty.
- Intellicore® polyurethane or bonded polystyrene insulation with R-values ranging from 18.4 to 6.3.
- Windows are standard with double strength clear glass and have optional snap-in grilles. Other glass options are available; see opposite page for available options.
- Section joints and bottom weatherseal in a corrosion-resistant retainer help seal out the elements.

Calculated door section R-value is in accordance with DASMA TDS-163

COLOR OPTIONS



**Not available on all models. Complete color availability can be found on pages 50–51.*

†Additional charges apply.

Ultra-Grain® finish is a faux woodgrain paint coating offering the beauty of stained wood without the upkeep.

Ultra Grain® finish doors will have either a stucco or woodgrain steel surface texture.

PANEL OPTIONS



Narrow



Extended

PANEL DETAIL

A true recessed stamp replicates the timeless look of a rail and stile built wood door.



MODEL SPECIFICATIONS

MODEL	BD2NU	BD2EU	BD1NU	BD1EU
Panel Style	Narrow	Extended	Narrow	Extended
Insulation	2" Intellicore® Polyurethane	2" Intellicore® Polyurethane	1-3/8" Intellicore® Polyurethane	1-3/8" Intellicore® Polyurethane
Construction	3-Layer	3-Layer	3-Layer	3-Layer
R-value	18.4	18.4	12.9	12.9

BRIDGEPORT™ STEEL



Bridgeport® Steel Narrow Panel, Shown in Standard White with Plain Long Windows

WINDOW OPTIONS

GLASS



Plain Short



REC12



SQ22



Plain Long



REC14



SQ24

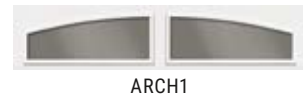

ARCH1



Vertical Grille on ARCH1



Grille on ARCH1



ARCH2



Vertical Grille on ARCH2



Grille on ARCH2

Additional double width door designs available.

Double strength glass is standard.

Long windows are available on narrow panel doors and short windows are available on extended panel doors.

Some limitations may apply based on W-Level. Contact your Clopay Dealer for details.

ACRYLIC



Wrought Iron Short



Wrought Iron Long



Wrought Iron Arch

Acrylic windows require special cleaning. See care and maintenance manual.

Impact rated windows available (Mocha Brown is not available on impact rated windows)

SPECIALTY GLASS OPTIONS

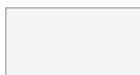

Clear



Frosted



Seeded



Obscure



Rain



Clear Polycarbonate



Bronze Polycarbonate



Matte Polycarbonate



Pebble Polycarbonate

Windows are available single pane or insulated in clear, frosted, seeded, obscure and rain designs.

Impact rated windows are available in clear, bronze, matte and pebble polycarbonate and may have a wavy appearance. Additional charges of optional glass apply.

MODEL SPECIFICATIONS

MODEL	BD4NV	BD4EV	BD4N	BD4E
Panel Style	Narrow	Extended	Narrow	Extended
Insulation	Polystyrene	Polystyrene	Non-Insulated	Non-Insulated
Construction	2-Layer	2-Layer	1-Layer	1-Layer
R-value	6.3	6.3	N/A	N/A

BRIDGEPORT™ STEEL

WINDCODE® AVAILABILITY CHART

Common Door Widths		W1	W3	W4	W5	W6	W7	W8
Model BD2NU	8', 9' Wide Door	S +13/-15 PSF	SELECT W4	FS +28/-29 PSF	SELECT W6	FTWS +38/-44 PSF	SELECT W8	FW +54/-60 PSF
	10', 12' Wide Door	S +12.5/-14 PSF	SELECT W4	FS +25.5/-25.5 PSF	FS +30/-30 PSF	TAPERED STRUT FTWS +38/-42 PSF	SELECT W8	TAPERED STRUT FW +46/-52 PSF
	16' Wide Door	S +12.5/-14 PSF	SELECT W4	FS +25.5/-25.5 PSF	FS +30/-30 PSF	TAPERED STRUT FTWS +38/-42 PSF	SELECT W8	TAPERED STRUT FW +46/-52 PSF
	18' Wide Door	S +12.5/-14 PSF	SELECT W4	F +25/-25 PSF	SELECT W6	TAPERED STRUT FTWS +38/-42 PSF		
Model BD2EU	8', 9' Wide Door	S +13/-15 PSF	SELECT W4	FS +28/-29 PSF	SELECT W6	FTWS +38/-44 PSF	SELECT W8	FW +54/-60 PSF
	10', 12' Wide Door	S +12.5/-14 PSF	SELECT W4	FS +25.5/-25.5 PSF	FS +30/-30 PSF	TAPERED STRUT FTWS +38/-42 PSF	SELECT W8	TAPERED STRUT FW +46/-52 PSF
	16' Wide Door	S +12.5/-14 PSF	SELECT W4	FS +25.5/-25.5 PSF	FS +30/-30 PSF	TAPERED STRUT FTWS +38/-42 PSF	SELECT W8	TAPERED STRUT FW +46/-52 PSF
	18' Wide Door	S +12.5/-14 PSF	SELECT W4	F +25/-25 PSF	SELECT W6	TAPERED STRUT FTWS +38/-42 PSF		
Model BD1NU	8', 9' Wide Door	S +13/-15 PSF	FS +20/-21 PSF					
	10', 12' Wide Door	S +12.5/-14 PSF	FS +20/-21 PSF	SELECT W5	F +30/-30 PSF			
	16' Wide Door	S +12.5/-14 PSF	FS +20/-21 PSF	SELECT W5	F +30/-30 PSF			
	18' Wide Door	S +12.5/-14 PSF						
Model BD1EU	8', 9' Wide Door	S +13/-15 PSF	FS +20/-21 PSF					
	10', 12' Wide Door	S +12.5/-14 PSF	FS +20/-21 PSF	SELECT W5	F +30/-30 PSF			
	16' Wide Door	S +12.5/-14 PSF	FS +20/-21 PSF	SELECT W5	F +30/-30 PSF			
	18' Wide Door	S +12.5/-14 PSF						

BRIDGEPORT™ STEEL

WINDCODE® AVAILABILITY CHART

Common Door Widths	W1	W3	W4	W5	W6	W7	W8	
BD4N 24 Gauge Pan Narrow	8', 9' Wide Door	S +13/-15 PSF	SELECT W4	FTS +25/-25 PSF	FTS +30/-32 PSF	FTW [†] S* +38/-44 PSF	SELECT W8	FDW +50/-58 PSF
	10', 12' Wide Door	S +12.5/-14 PSF	SELECT W4	FTS* +25/-25 PSF	FTS* +30/-30 PSF	TAPERED STRUT FWS* +38/-42 PSF	SELECT W8	FDW +46/-52 PSF
	16' Wide Door	S +12.5/-14 PSF	SELECT W4	FTS* +25/-25 PSF	FTS* +30/-30 PSF	TAPERED STRUT FWS* +38/-42 PSF	SELECT W8	FDW +46/-52 PSF
	18' Wide Door	S* +12.5/-14 PSF	SELECT W4	FTS* +25/-25 PSF				
BD4NV 24 Gauge Insulated Narrow	8', 9' Wide Door	S +13/-15 PSF	SELECT W4	FTS +25/-25 PSF	FTS +30/-32 PSF			
	10', 12' Wide Door	S +12.5/-14 PSF	SELECT W4	FTS* +25/-25 PSF	FTS* +30/-30 PSF			
	16' Wide Door	S +12.5/-14 PSF	SELECT W4	FTS* +25/-25 PSF	FTS* +30/-30 PSF			
	18' Wide Door	S* +12.5/-14 PSF	SELECT W4	FTS* +25/-25 PSF				
BD4E 24 Gauge Pan Extended	8', 9' Wide Door	S +13/-15 PSF	SELECT W4	FTS +25/-25 PSF	SELECT W6	FTW [†] S* +38/-44 PSF		
	10', 12' Wide Door	S +12.5/-14 PSF	SELECT W4	FTS* +25/-25 PSF	SELECT W6	TAPERED STRUT FS* +38/-42 PSF		
	16' Wide Door	S +12.5/-14 PSF	SELECT W4	FTS* +25/-25 PSF	SELECT W6	TAPERED STRUT FS* +38/-42 PSF		
	18' Wide Door	S* +12.5/-14 PSF	SELECT W4	FTS* +25/-25 PSF				
BD4EV 24 Gauge Insulated Extended	8', 9' Wide Door	S +13/-15 PSF	SELECT W4	FTS +25/-25 PSF				
	10', 12' Wide Door	S +12.5/-14 PSF						
	16' Wide Door	S +12.5/-14 PSF						
	18' Wide Door							

S Standard Windows Available **W** Patented Impact Windows Available **D** Dade County Approved
 Impact Rated **F** Florida Approved **T** Texas Department of Insurance Approved

For W6 - W8 doors over 9' wide, add 2" to the door width.
 For W6, Model BD4N 18' wide doors are available only at 7' high.
 Standard windows are not available in Texas.

* Long window availability is limited due to reinforcement requirements.
 † Impact windows are not available in Texas.

MODERN STEEL™

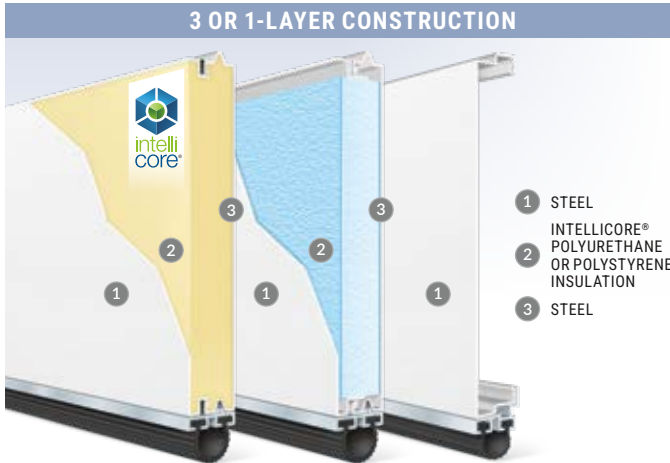

Modern Steel™ garage doors complement contemporary and mid-century modern home styles. Doors are available with or without windows and with or without grooves in the panels. All are available in multiple paint, Ultra-Grain® and Lustra™ finishes to create the perfect look for your home.

STYLE AND CONSTRUCTION

- Intellicore® polyurethane or bonded polystyrene insulation with R-values ranging from 18.4 to 6.5.
- Modern Flush and Grooved panels with a textured steel surface improve appearance close-up and from the curb.
- Replaceable vinyl bottom weatherseal in a corrosion-resistant retainer helps seal out the elements.

Calculated door section R-value is in accordance with DASMA TDS-163.

PANEL OPTIONS

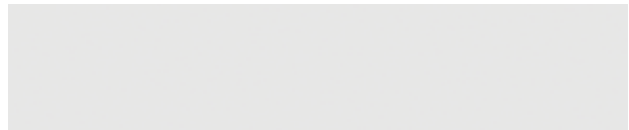

Modern Flush (9208, 9202, 9201, 9138, 9132, 9131, 4308, 4302, 4301, 4138, 4132, 4051, 4F, 4F4)



Modern Grooved (9209, 9205, 9139, 4309, 4305)

CONTEMPORARY WINDOW ORIENTATION

When ordering contemporary window configurations please reference the examples provided to describe your desired window positions. **Note: Window configurations are described from inside the garage looking out.**

For popular contemporary window configurations and window options see pages 34–35.

Example: Windows down right side (from inside garage looking out)

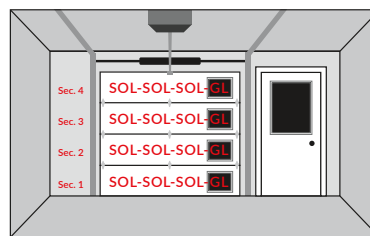

View from Inside Garage

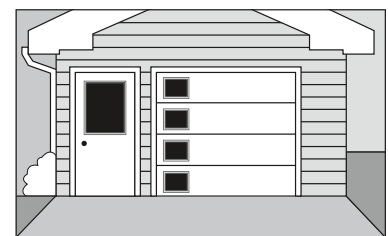

View from Outside Garage

MODEL SPECIFICATIONS

MODELS	9202, 9201	9208	9205	9209	9132, 9131	9138	9139
Panel Style	Modern Flush	Modern Flush with Contemporary Windows	Modern Grooved	Modern Grooved with Contemporary Windows	Modern Flush	Modern Flush with Contemporary Windows	Modern Grooved with Contemporary Windows
Steel Texture*	Woodgrain	Stucco/Smooth†	Stucco	Stucco/Smooth†	Woodgrain	Stucco	Stucco
Insulation	2" Intellicore® Polyurethane	2" Intellicore® Polyurethane	2" Intellicore® Polyurethane	2" Intellicore® Polyurethane	1-3/8" Intellicore® Polyurethane	1-3/8" Intellicore® Polyurethane	1-3/8" Intellicore® Polyurethane
Construction	3-Layer	3-Layer	3-Layer	3-Layer	3-Layer	3-Layer	3-Layer
R-value	18.4	18.4	18.4	18.4	12.9	12.9	12.9

MODERN STEEL™

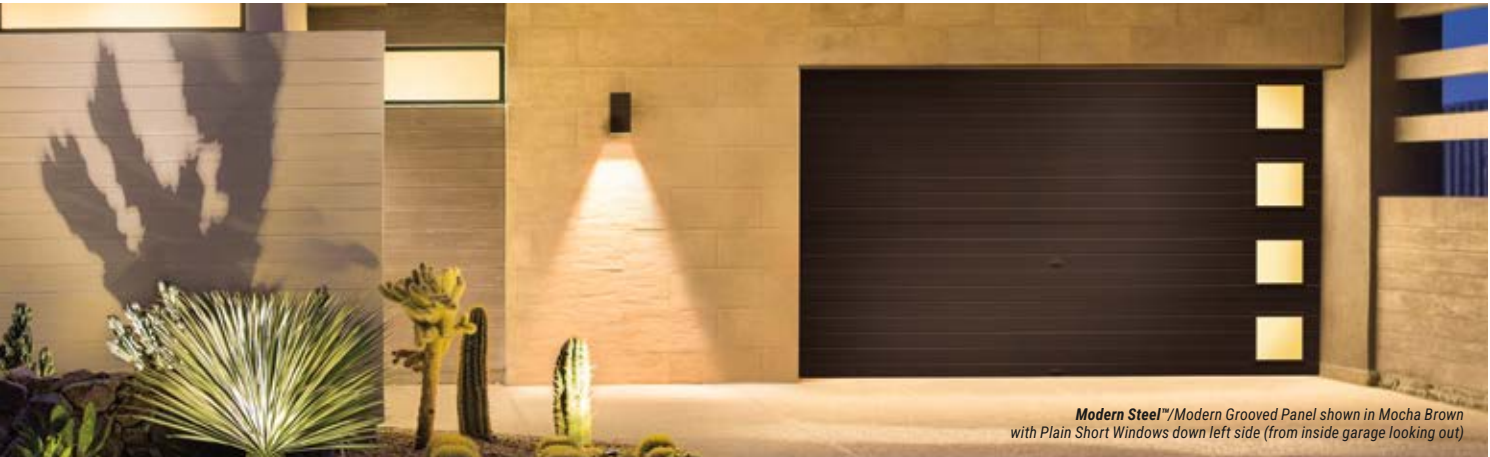

Modern Steel™ Modern Grooved Panel shown in Mocha Brown with Plain Short Windows down left side (from inside garage looking out)

COLOR OPTIONS

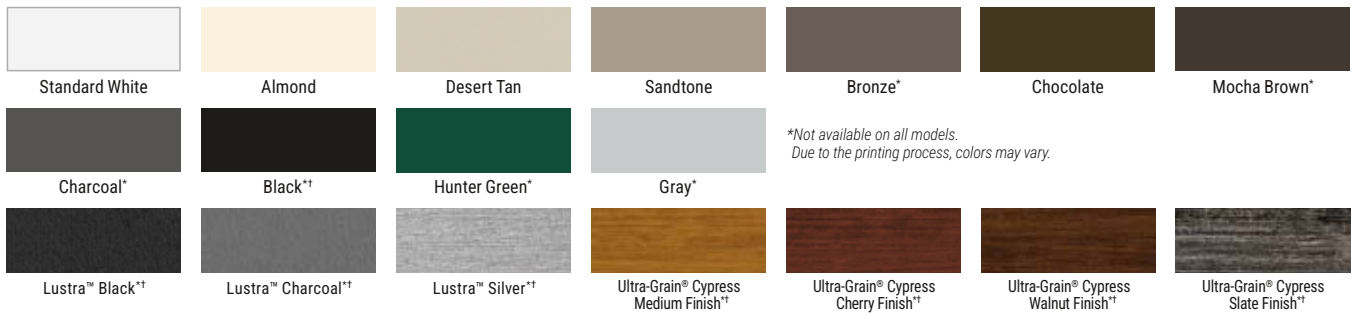

Complete color availability can be found on pages 50–51.
†Additional charges apply.

ULTRA-GRAIN® PLANK



Not available on all models. Complete color availability can be found on pages 50–51.
Due to the printing process, colors may vary. Additional charges apply.

MODEL SPECIFICATIONS

MODELS	4302, 4301	4308	4305	4309	4132, 4051	4138	4F, 4F4†
Panel Style	Modern Flush	Modern Flush with Contemporary Windows	Modern Grooved	Modern Grooved with Contemporary Windows	Modern Flush	Modern Flush with Contemporary Windows	Modern Flush
Steel Texture*	Woodgrain	Stucco	Stucco	Stucco	Woodgrain	Stucco	Woodgrain
Insulation	2" Bonded Polystyrene	2" Bonded Polystyrene	2" Bonded Polystyrene	2" Bonded Polystyrene	1-3/8" Bonded Polystyrene	1-3/8" Bonded Polystyrene	Non-Insulated
Construction	3-Layer	3-Layer	3-Layer	3-Layer	3-Layer	3-Layer	1-Layer
R-value	9.0	9.0	9.0	9.0	6.5	6.5	N/A

*Exterior steel surface on an Ultra-Grain® Cypress finish door has a woodgrain texture on Modern Steel™ garage doors.

†Exterior steel surface on a Lustra™ finish door has a smooth texture on Modern Steel™ garage doors.

‡Model 4F utilizes 21" and 18" sections while the Model 4F4 utilizes 24" and 21" sections.

MODERN STEEL™ WINDOW OPTIONS

DECORATIVE INSERT SERIES WINDOW OPTIONS

Available on These Models: 9201, 9131, 4301, 4051, 4F, 4F4



Plain Short



Plain Long



Charleston 508



Colonial 509



Prairie 510



Sunset 501* (4, 6, 8 or 10 panels across)



Sunset 502* (3, 6 or 9 panels across)



Sunset 503* (4 or 8 panels across)



Sunset 506* (5 or 10 panels across)



Sunset 504* (7 panels across only)



Sunset 505* (8 panels across only)



Charleston 608



Stockton 612



Prairie 610



Madison 611



Madison Arch 613



Sunset 601* (2, 3, 4 or 5 long panels across)



Sunset 603* (2 or 4 long panels across)



Sunset 605* (4 long panels across)

*Sunset windows not available on Ultra-Grain® finish doors.

DECORATIVE INSERT SERIES SPECIALTY GLASS OPTIONS

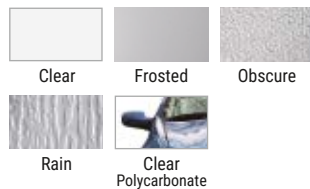

Plain and Snap-In Series windows are available single pane or insulated in clear, frosted, obscure and rain designs. Clear acrylic also available. Impact rated windows are available in clear polycarbonate and may have a wavy appearance.

Acrylic windows require special cleaning. See care and maintenance manual. Window heights may vary based on section height.

Impact rated windows available (Mocha Brown is not available on impact rated windows)

CONTEMPORARY/ARCHITECTURAL SERIES WINDOW OPTIONS

Available on These Models: 9202, 9201, 9208**†, 9205, 9209**†, 9132, 9131, 9138*, 9139*, 4302, 4301, 4308*, 4305, 4309*, 4132, 4138*



Plain Short



Plain Long



Plain Short**



Plain Long**



REC12



REC14



SQ22



SQ24



ARCH1



ARCH2



Vertical Grille on ARCH1



Vertical Grille on ARCH2



Grille on ARCH1



Grille on ARCH2



Wrought Iron Short (Acrylic)



Wrought Iron Long (Acrylic)



Wrought Iron Arch (Acrylic)

* Models available only with plain, rectangular grille and square grille windows.
 ** 7' high doors with impact rated windows utilize smaller glazing height to obscure reinforcement.
 † Ultra-Grain® Plank and Lustra™ finishes available only with plain windows. Additional double width door designs available. Double strength glass is standard. Contemporary/Architectural Series windows are not available on Modern Steel™ Models 4051, 4F and 4F4.

CONTEMPORARY/ARCHITECTURAL SERIES SPECIALTY GLASS OPTIONS



Contemporary/Architectural Series windows are available single pane or insulated in clear, frosted, obscure and narrow reed designs. Impact rated windows are available in clear, bronze, matte and pebble polycarbonate and may have a wavy appearance.

Additional charges for optional glass apply.

MODERN STEEL™

WINDCODE® AVAILABILITY CHART

Common Door Widths	W1	W2	W3	W4	W5	W6	W7	W8	W9
Models 9202, 9205	8', 9' Wide Door	S +13/-15 PSF	SELECT W6	SELECT W6	SELECT W6	SELECT W6	FTWS* +38/-44 PSF	SELECT W8	FW* +54/-60 PSF
	10', 12' Wide Door	S +12.5/-14 PSF	SELECT W6	SELECT W6	SELECT W6	SELECT W6	TAPERED STRUT FTWS* +38/-42 PSF	SELECT W8	TAPERED STRUT FW* +46/-52 PSF
	16' Wide Door	S +12.5/-14 PSF	SELECT W6	SELECT W6	SELECT W6	SELECT W6	TAPERED STRUT FTWS* +38/-42 PSF	SELECT W8	TAPERED STRUT FW* +46/-52 PSF
	18' Wide Door	S +12.5/-14 PSF	SELECT W6	SELECT W6	SELECT W6	SELECT W6	TAPERED STRUT FTWS* +38/-42 PSF		
Models 9208, 9209	8', 9' Wide Door	S +13/-15 PSF	SELECT W4	SELECT W4	FS +25/-25 PSF	SELECT W6	FTWS +38/-42 PSF	SELECT W8	FTDWS +54/-62 PSF
	10', 12' Wide Door	S +12.5/-14 PSF	SELECT W4	SELECT W4	FS+26/-28 PSF	SELECT W6	FTWS +38/-42 PSF	SELECT W8	U-BAR FTDWS +50/-56 PSF
	16' Wide Door	S +12.5/-14 PSF	SELECT W4	SELECT W4	FS +25/-25 PSF	SELECT W6	FTWS +38/-42 PSF	SELECT W8	FTDWS +46/-52 PSF
	18' Wide Door	S +12.5/-14 PSF	SELECT W4	SELECT W4	FS +25/-25 PSF				
Model 9201	8', 9' Wide Door	S +13/-15 PSF	SELECT W4	SELECT W4	FTS +28/-29 PSF	FS +30/-32 PSF	FTWS +38/-44 PSF	SELECT W8	FTW +48/-60 PSF
	10', 12' Wide Door	S +12.5/-14 PSF	SELECT W4	SELECT W4	FTS +25.5/-25.5 PSF	SELECT W6	U-BAR FWS +37/-40 PSF TAPERED STRUT FTWS +38/-42 PSF	SELECT W8	TAPERED STRUT FTW +46/-52 PSF
	16' Wide Door	S +12.5/-14 PSF	SELECT W4	SELECT W4	FTS +25.5/-25.5 PSF	SELECT W6	U-BAR FWS +37/-40 PSF TAPERED STRUT FTWS +38/-42 PSF	SELECT W8	TAPERED STRUT FTW +46/-52 PSF
	18' Wide Door	S +12.5/-14 PSF	SELECT W4	SELECT W4	FTS +24/-24.5 PSF	SELECT W6	TAPERED STRUT FTWS +38/-42 PSF	SELECT W8	TAPERED STRUT FTW +46/-50 PSF
Model 9131	8', 9' Wide Door	S +13/-15 PSF	SELECT W3	FS +20/-20 PSF	FS +25/-28 PSF	FWS +33/-37 PSF	FS +37/-37 PSF		
	10', 12' Wide Door	S +12.5/-14 PSF	SELECT W3	FS +20/-21 PSF	FS +24/-26 PSF	FS +32/-32 PSF			
	16' Wide Door	S +12.5/-14 PSF	SELECT W3	FS +20/-21 PSF	FS +24/-26 PSF	FS +32/-32 PSF			
	18' Wide Door	S +12.5/-14 PSF	SELECT W4	SELECT W4	FS +24/-26 PSF				
Models 9132, 9138, 9139	8', 9' Wide Door	S +13/-15 PSF							
	10', 12' Wide Door	S +12.5/-14 PSF							
	16' Wide Door	S +12.5/-14 PSF							
	18' Wide Door	S +12.5/-14 PSF							
Models 4302, 4305	8', 9' Wide Door	S +13/-15 PSF	SELECT W6	SELECT W6	SELECT W6	SELECT W6	FTWS† +38/-44 PSF	SELECT W8	FDW† +54/-60 PSF
	10', 12' Wide Door	S +12.5/-14 PSF	SELECT W6	SELECT W6	SELECT W6	SELECT W6	TAPERED STRUT FTDWS† +38/-42 PSF	SELECT W8	TAPERED STRUT FDW† +46/-52 PSF
	16' Wide Door	S +12.5/-14 PSF	SELECT W6	SELECT W6	SELECT W6	SELECT W6	TAPERED STRUT FTDWS† +38/-42 PSF	SELECT W8	TAPERED STRUT FDW† +46/-52 PSF
	18' Wide Door	S +12.5/-14 PSF	SELECT W6	SELECT W6	SELECT W6	SELECT W6	TAPERED STRUT FTWS† +38/-42 PSF		
	20'2" Wide Door		SELECT W5	SELECT W5	SELECT W5	SELECT W5	FS +30/-33 PSF		

MODERN STEEL™

WINDCODE® AVAILABILITY CHART

Common Door Widths		W1	W2	W3	W4	W5	W6	W7	W8	W9
Models 4308, 4309	8', 9' Wide Door	S +13/-15 PSF								
	10', 12' Wide Door	S +12.5/-14 PSF								
	16' Wide Door	S +12.5/-14 PSF								
	18' Wide Door	S +12.5/-14 PSF								
Model 4301	8', 9' Wide Door	S +13/-15 PSF	SELECT W4	SELECT W4	FTWS +28/-29 PSF	SELECT W6	FTWS +38/-44 PSF	SELECT W8	FDTW +48/-60 PSF	
	10', 12' Wide Door	S +12.5/-14 PSF	SELECT W4	SELECT W4	FTWS +25.5/-25.5 PSF	SELECT W6	TAPERED STRUT FTDWS +38/-42 PSF	SELECT W8	TAPERED STRUT FTDWS +46/-52 PSF	
	16' Wide Door	S +12.5/-14 PSF	SELECT W4	SELECT W4	FTWS +25.5/-25.5 PSF	SELECT W6	TAPERED STRUT FTDWS +38/-42 PSF	SELECT W8	TAPERED STRUT FTDWS +46/-52 PSF	
	18' Wide Door	S +12.5/-14 PSF	SELECT W4	SELECT W4	FTWS +25.5/-25.5 PSF	SELECT W6	TAPERED STRUT FTDWS +38/-42 PSF	SELECT W8	TAPERED STRUT FTDWS +46/-50 PSF	
	20'2" Wide Door		SELECT W5	SELECT W5	SELECT W5	FS +30/-33 PSF	TAPERED STRUT FTW +37/-40 PSF			
Model 4132	8', 9' Wide Door	S +13/-15 PSF								
	10', 12' Wide Door	S +12.5/-14 PSF								
	16' Wide Door	S +12.5/-14 PSF								
	18' Wide Door	S +12.5/-14 PSF								
Model 4138	8', 9' Wide Door	S +13/-15 PSF								
	10', 12' Wide Door	S +12.5/-14 PSF								
	16' Wide Door	S +12.5/-14 PSF								
	18' Wide Door	S +12.5/-14 PSF								
Model 4051	8', 9' Wide Door	S +13/-15 PSF	SELECT W3	FS +20/-21 PSF	SELECT W6	SELECT W6	FS +37/-37 PSF	FS +38/-42 PSF		
	10', 12' Wide Door	S +12.5/-14 PSF	SELECT W3	FS +20/-21 PSF	SELECT W5	FS +30/-30 PSF or +32/-32 PSF				
	16' Wide Door	S +12.5/-14 PSF	SELECT W3	FS +20/-21 PSF	SELECT W5	FS +30/-30 PSF or +32/-32 PSF				
	18' Wide Door	S +12.5/-14 PSF								
Model 4F	8', 9' Wide Door		SELECT W8	SELECT W8	SELECT W8	SELECT W8	SELECT W8	SELECT W8	FW† +48/-54 or +54/-62 PSF	FDW +62/-72 PSF
	10', 12' Wide Door		SELECT W6	SELECT W6	SELECT W6	SELECT W6	TAPERED STRUT FTDWS* +38/-42 PSF	FDW +42/-48 PSF	TAPERED STRUT FDW +46/-50 PSF	
	16' Wide Door		SELECT W6	SELECT W6	SELECT W6	SELECT W6	TAPERED STRUT FTDWS* +38/-42 or +36/-42 PSF	SELECT W8	TAPERED STRUT FDW +46/-50 PSF	
	18' Wide Door		SELECT W6	SELECT W6	SELECT W6	SELECT W6	TAPERED STRUT FTDWS* +36/-42 PSF	TAPERED STRUT FDW +41/-46 PSF		
Model 4F4	8', 9' Wide Door	S +13/-15 PSF	SELECT W4	SELECT W4	FS +25/-25 PSF					
	10', 12' Wide Door	S +12.5/-14 PSF	SELECT W4	SELECT W4	FS +25/-25 PSF					
	16' Wide Door	S +12.5/-14 PSF	SELECT W4	SELECT W4	FS +25/-25 PSF					

S Standard Windows Available
 Impact Rated

W Patented Impact Windows Available
 F Florida Approved

D Dade County Approved
 T Texas Department of Insurance Approved

For W6 - W8 doors over 9' wide, add 2" to the door width.
 Standard windows are not available in Texas.

*Model 9205 is not Texas approved.
 †Model 4305 is not Florida, Dade or Texas approved.

PREMIUM

3-LAYER CONSTRUCTION



3-layer, steel construction features Intellicore® polyurethane or bonded polystyrene insulation sandwiched between two layers of heavy-duty steel for excellent energy efficiency, strength, durability and quietest operation.

STYLE AND CONSTRUCTION

- 3-layer construction (steel + insulation + steel).
- Tongue-and-groove section joint and bottom weatherseal in a corrosion-resistant retainer help seal out the elements.
- Woodgrain embossed, insulated steel base door painted front and back for a clean appearance.
- Prepainted Standard White end stiles and interior steel backing for a clean appearance.
- R-values range from 18.4 to 6.5.

Calculated door section R-value is in accordance with DASMA TDS-163.

PANEL OPTIONS

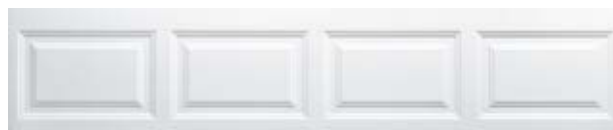

Elegant Short (9200, 9130, 4300, 4050)



Elegant Long (9203, 9133, 4310, 4053)

COLOR OPTIONS

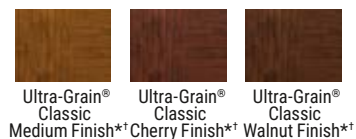

*Due to the printing process, colors may vary.
*Not available on all models. Complete color availability can be found on pages 50-51.
**Not available on 4050, 4053 and W8 doors.
†Additional charges apply.*

PANEL DETAIL

Decorative panel edging and natural embossed woodgrain or stucco (Ultra-Grain® finish only) texture improve appearance close-up and from the curb.



MODEL SPECIFICATIONS

MODEL	9200, 9203	9130, 9133	4300, 4310	4050, 4053
Panel Style	Elegant Short and Long	Elegant Short and Long	Elegant Short and Long	Elegant Short and Long
Insulation	2" Intellicore® Polyurethane	1-3/8" Intellicore® Polyurethane	2" Bonded Polystyrene	1-3/8" Bonded Polystyrene
Construction	3-Layer	3-Layer	3-Layer	3-Layer
R-value	18.4	12.9	9.0	6.5

CLASSIC™ STEEL PREMIUM WINDOW OPTIONS

DECORATIVE INSERT SERIES WINDOW OPTIONS

Available on These Models: 9200*, 9203, 9130*, 9133, 4300*, 4310, 4050*, 4053



Plain Short



Plain Long



Charleston 508



Colonial 509



Prairie 510



Sunset 501* (4, 6, 8 or 10 panels across)



Sunset 502* (3, 6 or 9 panels across)



Sunset 503* (4 or 8 panels across)



Sunset 506* (5 or 10 panels across)



Sunset 504* (7 panels across only)



Sunset 505* (8 panels across only)



Charleston 608



Stockton 612



Prairie 610



Madison 611



Madison Arch 613



Sunset 601* (2, 3, 4 or 5 long panels across)



Sunset 603* (2 or 4 long panels across)



Sunset 605* (4 long panels across)

*Sunset windows not available on Ultra-Grain® finish doors.

DECORATIVE INSERT SERIES SPECIALTY GLASS OPTIONS



Plain and Snap-In Series windows are available single pane or insulated in clear, frosted, obscure and rain designs. Clear acrylic also available. Impact rated windows are available in clear polycarbonate and may have a wavy appearance.

Acrylic windows require special cleaning. See care and maintenance manual. Window heights may vary based on section height.

Impact rated windows available (Mocha Brown is not available on impact rated windows)

ARCHITECTURAL SERIES WINDOW OPTIONS

Available on These Models: 9200*, 9203, 9130*, 9133, 4300*, 4310



Plain Short



Plain Long



REC12



REC14



SQ22



SQ24



ARCH1



ARCH2



Vertical Grille on ARCH1



Vertical Grille on ARCH2



Grille on ARCH1



Grille on ARCH2



Wrought Iron Short (Acrylic)



Wrought Iron Long (Acrylic)

* Panel emboss may not align with windows due to size difference. Some size limitations apply.



Wrought Iron Arch (Acrylic)

Additional double width door designs available. Double strength glass is standard.

ARCHITECTURAL SERIES SPECIALTY GLASS OPTIONS



Architectural Series windows are available single pane or insulated in clear, frosted, seeded, obscure and rain designs. Impact rated windows are available in clear, bronze, matte and pebble polycarbonate and may have a wavy appearance.

Additional charges for optional glass apply.

PREMIUM

WINDCODE® AVAILABILITY CHART

Common Door Widths		W1	W3	W4	W5	W6		W7	W8
Model 9200	8', 9' Wide Door	S +13/-15 PSF	SELECT W4	FTS +28/-29 PSF	FS +30/-32 PSF	FTWS +38/-44 PSF		SELECT W8	FTW +48/-60 PSF
	10', 12' Wide Door	S +12.5/-14 PSF	SELECT W4	FTS +25.5/-25.5 PSF	SELECT W6	U-BAR FWS +37/-40 PSF	TAPERED STRUT FTWS +38/-42 PSF	SELECT W8	TAPERED STRUT FTW +46/-52 PSF
	16' Wide Door	S +12.5/-14 PSF	SELECT W4	FTS +25.5/-25.5 PSF	SELECT W6	U-BAR FWS +37/-40 PSF	TAPERED STRUT FTWS +38/-42 PSF	SELECT W8	TAPERED STRUT FTW +46/-52 PSF
	18' Wide Door	S +12.5/-14 PSF	SELECT W4	FTS +24/-24.5 PSF	SELECT W6	TAPERED STRUT FTWS +38/-42 PSF		SELECT W8	TAPERED STRUT FTW +46/-50 PSF
Model 9203	8', 9' Wide Door	S +13/-15 PSF	SELECT W4	FTS +28/-29 PSF	FS +30/-32 PSF	FTS +38/-44 PSF		SELECT W8	FT +48/-60 PSF
	10', 12' Wide Door	S +12.5/-14 PSF	SELECT W4	FTS +25.5/-25.5 PSF	SELECT W6	U-BAR FS +37/-40 PSF	TAPERED STRUT FTS +38/-42 PSF	SELECT W8	TAPERED STRUT FT +46/-52 PSF
	16' Wide Door	S +12.5/-14 PSF	SELECT W4	FTS +25.5/-25.5 PSF	SELECT W6	U-BAR FS +37/-40 PSF	TAPERED STRUT FTS +38/-42 PSF	SELECT W8	TAPERED STRUT FT +46/-52 PSF
	18' Wide Door	S +12.5/-14 PSF	SELECT W4	FTS +24/-24.5 PSF	SELECT W6	TAPERED STRUT FTS +38/-42 PSF		SELECT W8	TAPERED STRUT FT +46/-50 PSF
Model 9130	8', 9' Wide Door	S +13/-15 PSF	FS +20/-20 PSF	FS +25/-28 PSF	FWS +33/-37 PSF	FS +37/-37 PSF			
	10', 12' Wide Door	S +12.5/-14 PSF	FS +20/-21 PSF	FS +24/-26 PSF	FWS +32/-32 PSF				
	16' Wide Door	S +12.5/-14 PSF	FS +20/-21 PSF	FS +24/-26 PSF	FWS +32/-32 PSF				
	18' Wide Door	S +12.5/-14 PSF	SELECT W4	FS +24/-26 PSF					
Model 9133	8', 9' Wide Door	S +13/-15 PSF	FS +20/-20 PSF	FS +25/-28 PSF	FS +33/-37 PSF	FS +37/-37 PSF			
	10', 12' Wide Door	S +12.5/-14 PSF	FS +20/-21 PSF	FS +24/-26 PSF	FS +32/-32 PSF				
	16' Wide Door	S +12.5/-14 PSF	FS +20/-21 PSF	FS +24/-26 PSF	FS +32/-32 PSF				
	18' Wide Door	S +12.5/-14 PSF	SELECT W4	FS*	+24/-26 PSF				
Model 4300	8', 9' Wide Door	S +13/-15 PSF	SELECT W4	FTWS +28/-29 PSF	SELECT W6	FTWS +38/-44 PSF		SELECT W8	FDTW +48/-60 PSF
	10', 12' Wide Door	S +12.5/-14 PSF	SELECT W4	FTWS +25.5/-25.5 PSF	SELECT W6	TAPERED STRUT FTDWS +38/-42 PSF		SELECT W8	TAPERED STRUT FTDWS +46/-52 PSF
	16' Wide Door	S +12.5/-14 PSF	SELECT W4	FTWS +25.5/-25.5 PSF	SELECT W6	TAPERED STRUT FTDWS +38/-42 PSF		SELECT W8	TAPERED STRUT FTDWS +46/-52 PSF
	18' Wide Door	S +12.5/-14 PSF	SELECT W4	FTWS +25/-25 PSF	SELECT W6	TAPERED STRUT FTDWS +38/-42 PSF		SELECT W8	TAPERED STRUT FTDWS +46/-50 PSF
	20'2" Wide Door	SELECT W5	SELECT W5	SELECT W5	FS +30/-33 PSF	TAPERED STRUT FTW +37/-40 PSF			
Model 4310	8', 9' Wide Door	S +13/-15 PSF	SELECT W4	FTS +28/-29 PSF	SELECT W6	FTS +38/-44 PSF		SELECT W8	FDT +48/-60 PSF
	10', 12' Wide Door	S +12.5/-14 PSF	SELECT W4	FTS +25.5/-25.5 PSF	SELECT W6	TAPERED STRUT FTDS +38/-42 PSF		SELECT W8	TAPERED STRUT FTD +46/-52 PSF
	16' Wide Door	S +12.5/-14 PSF	SELECT W4	FTS +25.5/-25.5 PSF	SELECT W6	TAPERED STRUT FTDS +38/-42 PSF		SELECT W8	TAPERED STRUT FTD +46/-52 PSF
	18' Wide Door	S +12.5/-14 PSF	SELECT W4	FTS +25/-25 PSF	SELECT W6	TAPERED STRUT FTDS +38/-42 PSF		SELECT W8	TAPERED STRUT FTD +46/-50 PSF
	20'2" Wide Door	SELECT W5	SELECT W5	SELECT W5	F +30/-33 PSF	TAPERED STRUT FTW +37/-40 PSF			
Model 4050	8', 9' Wide Door	S +13/-15 PSF	FS +20/-21 PSF	SELECT W6	SELECT W6	FS +37/-37 PSF	FS +38/-42 PSF		
	10', 12' Wide Door	S +12.5/-14 PSF	FS +20/-21 PSF	SELECT W5	FS +30/-30 PSF or +32/-32 PSF				
	16' Wide Door	S +12.5/-14 PSF	FS +20/-21 PSF	SELECT W5	FS +30/-30 PSF or +32/-32 PSF				
	18' Wide Door	S +12.5/-14 PSF							
Model 4053	8', 9' Wide Door	S +13/-15 PSF	FS +20/-21 PSF	SELECT W6	SELECT W6	FS +37/-37 PSF	FS +38/-42 PSF		
	10', 12' Wide Door	S +12.5/-14 PSF	FS +20/-21 PSF	SELECT W5	FS +30/-30 PSF or +32/-32 PSF				
	16' Wide Door	S +12.5/-14 PSF	FS +20/-21 PSF	SELECT W5	FS +30/-30 PSF or +32/-32 PSF				
	18' Wide Door	S +12.5/-14 PSF							

S Standard Windows Available
 Impact Rated

W Patented Impact Windows Available
 F Florida Approved

D Dade County Approved
 T Texas Department of Insurance Approved

*Some heights not available due to weight restrictions.
 For W6-W8 doors over 9' wide, add 2" to the door width.

Standard windows are not available in Texas.

VALUE PLUS (builder grade)

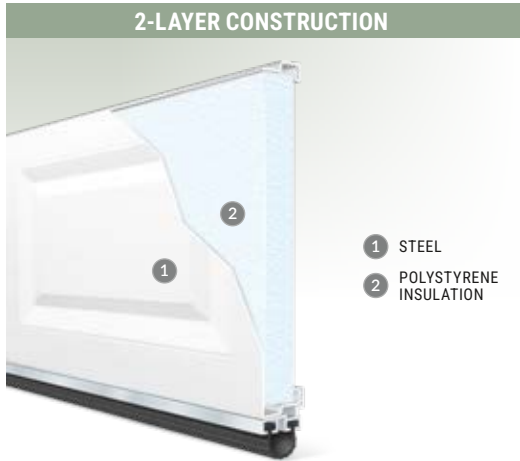

MODEL SPECS			
MODELS	76V/76VSP	94V	1500/15SP
Panel Styles	Long	Short	Short
Section Joint	Shiplap	Shiplap	Shiplap
Steel Gauge	25	24	25
Insulation Thickness	1-5/16"	1-5/16"	1-5/16"

Heavy-duty, 2-layer, steel construction with insulation for added comfort, energy efficiency and quiet operation.

STYLE AND CONSTRUCTION

- 2-layer construction (steel + vinyl-backed polystyrene insulation).
- Woodgrain embossed, insulated steel base door painted front and back for a virtually maintenance-free door.
- Quality 24 or 25 gauge steel and 2" thick frame construction for durability and longevity.
- Vinyl-backed insulation for a clean interior appearance.
- Polystyrene insulation: R-value 6.3.

Calculated door section R-value is in accordance with DASMA TDS-163.

PANEL OPTIONS



Traditional Short (1500, 15SP, 94V)



Traditional Long (76V, 76VSP)

COLOR OPTIONS



Due to the printing process, colors may vary. *Not available on all models. Complete color availability can be found on pages 50-51. Additional charges apply.

WINDCODE® AVAILABILITY CHART									
Common Door Widths		W1**	W2	W3	W4	W5			
USE T52									
Models 1500/15SP	8', 9' Wide Door	S +13/-15 PSF	S +16/-18.5 PSF	FS +20/-21 PSF	FTW'S +25/-32 PSF	1500	FTW'S +30/-32 PSF	15SP	FTW'S +32/-37 PSF
	10', 12' Wide Door	S +12.5/-14 PSF	S +15.5/-17 PSF	FS +20/-21 PSF	FTW'S* +24/-24.5 PSF	1500	FTW'S +30/-30 or +28/-30.5 or +32/-32 PSF	15SP	TAPERED STRUT FTW'S +32/-37 PSF
	16' Wide Door	S +12.5/-14 PSF	S +15.5/-17 PSF	FS +20/-21 PSF	FTW'S* +24/-24.5 PSF	1500	FTW'S +30/-30 or +28/-30.5 or +32/-32 PSF	15SP	TAPERED STRUT FTW'S +32/-37 PSF
	18' Wide Door	S +12.5/-14 PSF	SELECT W4	SELECT W4	TAPERED STRUT FTW'S* +25/-27 PSF	1500			
Model 94V	8', 9' Wide Door	S +13/-15 PSF	S +16/-18.5 PSF	FS +20/-21 PSF	FTWS +25/-32 PSF		FTWS +30/-32 PSF		
	10', 12' Wide Door	S +12.5/-14 PSF	S +15.5/-17 PSF	FS +20/-21 PSF	FTW'S* +24/-24.5 PSF		FTWS +30/-30 or +28/-30.5 or +32/-32 PSF		
	16' Wide Door	S +12.5/-14 PSF	S +15.5/-17 PSF	FS +20/-21 PSF	FTW'S* +24/-24.5 PSF		FTWS +30/-30 or +28/-30.5 or +32/-32 PSF		
	18' Wide Door	S +12.5/-14 PSF	SELECT W4	SELECT W4	FTW'S* +25/-25 PSF				
Models 76V/76VSP	8', 9' Wide Door	S +13/-15 PSF	SELECT W4	SELECT W4	FT +25/-32 PSF	76V	FT +30/-32 PSF	76VSP	F +32/-37 PSF
	10', 12' Wide Door	S +12.5/-14 PSF	SELECT W5	SELECT W5	SELECT W5		SELECT W5	76VSP	TAPERED STRUT F +32/-37 PSF
	16' Wide Door	S +12.5/-14 PSF	SELECT W5	SELECT W5	SELECT W5		SELECT W5	76VSP	TAPERED STRUT F +32/-37 PSF
	18' Wide Door	S +12.5/-14 PSF							

S Standard Windows Available W Patented Impact Windows Available D Dade County Approved
 Impact Rated F Florida Approved T Texas Department of Insurance Approved

For W6-W8 doors over 9' wide, add 2" to the door width. **For W1, Model T52 is used. Model T52 is a tongue-and-groove, 2-layer door. *Impact windows are not available in Texas.

VALUE (builder grade)

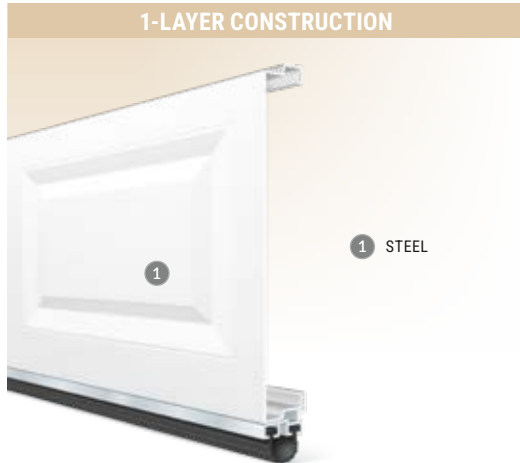

MODEL SPECS			
MODELS	73	76	94
Panel Styles	Traditional Short	Traditional Long	Traditional Short
Steel Gauge	25	25	24
Insulation Thickness	N/A	N/A	N/A

PANEL OPTIONS



Traditional Short (73, 94)



Traditional Long (76)

Single-layer, non-insulated steel construction provides beauty and durability at an economical value.

STYLE AND CONSTRUCTION

- 1-layer construction (steel).
- Woodgrain embossed steel base door painted front and back for a virtually maintenance-free door.
- Quality 24 or 25 gauge steel and 2" thick frame construction for durability and longevity.
- Woodgrain textured short and long raised panel designs in 1-layer construction complement traditional home styles.

COLOR OPTIONS



Standard White Almond Desert Tan Sandtone Chocolate Black*

Due to the printing process, colors may vary.

**Not available on all models. Complete color availability can be found on pages 50-51. Additional charges apply.*

WINDCODE® AVAILABILITY CHART

Common Door Widths		W1**	W2	W3	W4	W5	W6	W7	W8	W9
USE T50										
Model 94	8', 9' Wide Door	S +13/-15 PSF	S +16/-18.5 PSF	FS +20/-21 PSF	FTWS +25/-32 PSF	FTWS +30/-32 PSF	FTWS* +38/-42 PSF	FDW +42/-48 PSF	FW+ +48/-54 or +54/-62 PSF	FDW +62/-72 PSF
	10', 12' Wide Door	S +12.5/-14 PSF	S +15.5/-17 PSF	FS +20/-21 PSF	FTWS* +24/-24.5 PSF	FTWS +30/-30 or +28/-30.5 or +32/-32 PSF	TAPERED STRUT FTDWS* +38/-42 PSF	FW +42/-48 PSF	TAPERED STRUT FDW +46/-50 PSF	
	16' Wide Door	S +12.5/-14 PSF	S +15.5/-17 PSF	FS +20/-21 PSF	FTWS* +24/-24.5 PSF	FTWS +30/-30 or +28/-30.5 or +32/-32 PSF	TAPERED STRUT FTDWS* +38/-42 or +36/-42 PSF	FW +42/-48 PSF	TAPERED STRUT FDW +46/-50 PSF	
	18' Wide Door	S +12.5/-14 PSF	SELECT W4	SELECT W4	FTWS* +25/-25 PSF	SELECT W6	TAPERED STRUT FTDWS* +36/-42 PSF	TAPERED STRUT FDW +41/-46 PSF		

VALUE (builder grade)



WINDCODE® AVAILABILITY CHART

Common Door Widths		W1**	W2	W3	W4	W5		W6	W7	W8
USE T50										
Models 73/73SP	8', 9' Wide Door	S +13/-15 PSF	S +16/-18.5 PSF	FS +20/-21 PSF	FTW†S +25/-32 PSF	73 FTW†S +30/-32 PSF	73SP FWS +32/-37 PSF	FTWS +38/-44 PSF	FW +42/-48 PSF	FW +46/-50 PSF
	10', 12' Wide Door	S +12.5/-14 PSF	S +15.5/-17 PSF	FS +20/-21 PSF	FTW†S +24/-24.5 PSF	73 FTW†S +28/-30.5 or +30/-30 or +32/-32 PSF	TAPERED STRUT 73SP FWS +32/-37 PSF	TAPERED STRUT FTWS +36/-42 PSF		
	16' Wide Door	S +12.5/-14 PSF	S +15.5/-17 PSF	FS +20/-21 PSF	FTW†S +24/-24.5 PSF	73 FTW†S +28/-30.5 or +30/-30 or +32/-32 PSF	TAPERED STRUT 73SP FWS +32/-37 PSF	TAPERED STRUT FTWS +36/-42 PSF		
	18' Wide Door	S +12.5/-14 PSF	SELECT W4	SELECT W4	TAPERED STRUT 73 FTW†S +25/-27 PSF	SELECT W6		TAPERED STRUT FTWS +36/-42 PSF		
Models 76/76SP	8', 9' Wide Door	S +13/-15 PSF	S +16/-18.5 PSF	FS +20/-21 PSF	FTW†S +25/-32 PSF	76 FT +30/-32 PSF	76SP F +32/-37 PSF	FT +38/-44 PSF		
	10', 12' Wide Door	S +12.5/-14 PSF	S +15.5/-17 PSF	FS +20/-21 PSF	SELECT W5	76 FT +28/-30.5 or +30/-30 or +32/-32 PSF	TAPERED STRUT 76SP F +32/-37 PSF	TAPERED STRUT F +36/-42 PSF		
	16' Wide Door	S +12.5/-14 PSF	S +15.5/-17 PSF	FS +20/-21 PSF	SELECT W5	76 FT +28/-30.5 or +30/-30 or +32/-32 PSF	TAPERED STRUT 76SP F +32/-37 PSF	TAPERED STRUT F +36/-42 PSF		
	18' Wide Door	+12.5/-14 PSF	SELECT W4	SELECT W4	TAPERED STRUT 76 FTW†S +25/-27 PSF					
		S Standard Windows Available			W Patented Impact Windows Available			D Dade County Approved		
		Impact Rated			F Florida Approved			T Texas Department of Insurance Approved		

For W6 – W8 doors over 9' wide, add 2" to the door width.

For W6, Model 76 doors are not available over 16'2" wide.

*Long window availability is limited due to reinforcement requirements.

**For W1, Model T50 is used. Model T50 is a tongue-and-groove, 1-layer door.

†Impact windows available at +48/-54 PSF.

‡Impact windows not available in Texas.

VALUE PLUS & VALUE



Value Traditional Short Panel with Prairie 510 Window Design shown in Standard White

WINDOW OPTIONS

DECORATIVE INSERT SERIES

Available on These Models: 73, 73SP, 76, 76SP, 76V, 76VSP, 94, 94V, 1500, 15SP



Plain Short



Plain Long



Charleston 508



Colonial 509



Prairie 510



Sunset 501 (4, 6, 8 or 10 panels across)



Sunset 502 (3, 6 or 9 panels across)



Sunset 503 (4 or 8 panels across)



Sunset 504 (7 panels across only)



Sunset 505 (8 panels across only)



Sunset 506 (5 or 10 panels across)



Charleston 608



Prairie 610



Stockton 612



Madison 611



Madison Arch 613



Sunset 601 (2, 3, 4 or 5 long panels across)



Sunset 603 (2 or 4 long panels across)



Sunset 605 (4 long panels across)

SPECIALTY GLASS OPTIONS



Clear Frosted Obscure
Rain Clear Polycarbonate

Plain and Snap-In Series windows are available single pane or insulated in clear, frosted, obscure and rain designs. Clear acrylic also available. Impact rated windows are available in clear polycarbonate and may have a wavy appearance. Additional charges for optional glass apply.

Acrylic windows require special cleaning. See care and maintenance manual. Window heights may vary based on section height.

Impact rated windows available (Mocha Brown is not available on impact rated windows)

GRAND HARBOR® (builder grade)

HANDCRAFTED 3 OR 2-LAYER CONSTRUCTION



When budget is the deciding factor, this low maintenance, insulation-optional steel frame, carriage house style garage door combines clean lines and classic charm to provide a popular style at a great value. Accented with decorative black wrought iron hardware, these doors have the appearance of a swing-out door, but offer the convenience of modern overhead operation.

STYLE AND CONSTRUCTION

- Woodgrain embossed 24 gauge, 2" steel frame construction with 1/2" smooth composite overlay creates authentic carriage house styling.
- Model GH is non-insulated.
- Model GHV has 1-5/8" vinyl-backed insulation that improves energy efficiency with a 6.3 R-value.
- Available in 8 different designs.
- Window options include square, rectangular and arch windows with removable grilles. Glazing includes DSB clear or obscure glass and acrylic wrought iron designs. Unique faux window top sections are also an option.

Calculated door section R-value is in accordance with DASMA TDS-163.

COLOR OPTIONS



DOOR DESIGNS

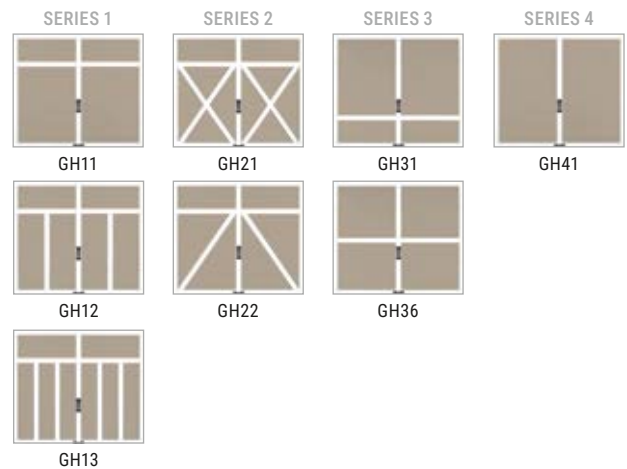

WINDOW OPTIONS

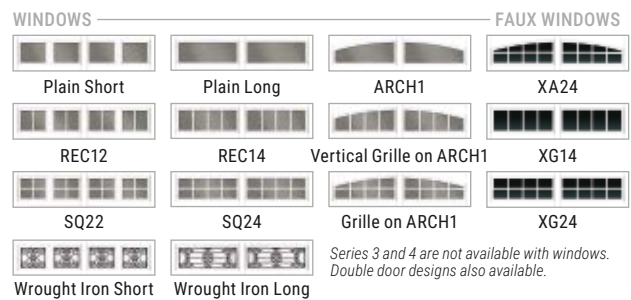

Acrylic windows require special cleaning. See care and maintenance manual.

WINDCODE® AVAILABILITY CHART

Common Door Widths	W1	W3	W4	W5	W6	W7	W8
8', 9' Wide Door	S +12/-15 PSF	SELECT W4	FS +25/-32 PSF	FS* +30/-32 PSF	FTS* +38/-44 PSF	SELECT W8	FD +50/-58 PSF
16' Wide Door	S +12.5/-14 PSF	SELECT W4	FS* +24/-24.5 PSF	FS* +30/-30 PSF	TAPERED STRUT FTS* +38/-42 PSF	SELECT W8	FD +46/-52 PSF
18' Wide Door	S +12.5/-14 PSF	SELECT W4	FS* +25/-25 PSF				

S Standard Windows Available
Impact Rated

W Patented Impact Windows Available
F Florida Approved

D Dade County Approved
T Texas Department of Insurance Approved

For W6-W8 doors over 9' wide, add 2" to the door width.
*Long window availability is limited due to reinforcement requirements.

LIMITED EDITION

HANDCRAFTED 5 OR 4-LAYER CONSTRUCTION

- 1 WOOD OVERLAY
- 2 OPTIONAL BASE MATERIAL
- 3 BASE MATERIAL
- 4 POLYSTYRENE INSULATED HEMLOCK FRAME
- 5 2" LUAN INSIDE SKIN

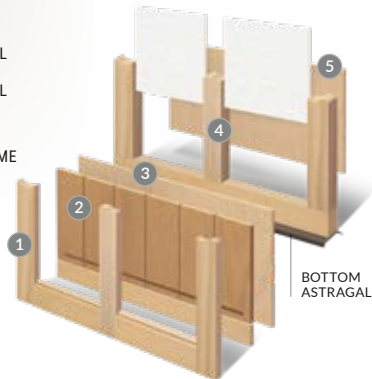

Distinguish your home with Clopay's Reserve® Wood Limited Edition garage doors, a line of eight polystyrene insulated wood door styles based on the most inspired (and requested) custom designs.

STYLE AND CONSTRUCTION

- Doors are available in 8 designs with 13 window/top section styles.
- Standard and optional decorative hardware available.
- Handcrafted, 5 or 4-layer construction, polystyrene insulated wood door with a 5.9 R-value.
- 1/4" thick, imported hardwood interior backer glued to stiles and rails.
- Tongue-and-groove section joint.
- All doors can be factory primed or finish painted White. Factory stain available for stained grade wood species.

Calculated door section R-value is in accordance with DASMA TDS-163.

SPECIALTY GLASS OPTIONS



Windows are single pane and double strength 1/8" thick. Additional charges for optional glass apply.

DOOR DESIGNS

Doors shown 8' wide x 7' high.



WINDOW OPTIONS



Double door designs also available.

MATERIAL OPTIONS

OVERLAYS



BASE FACE MATERIALS

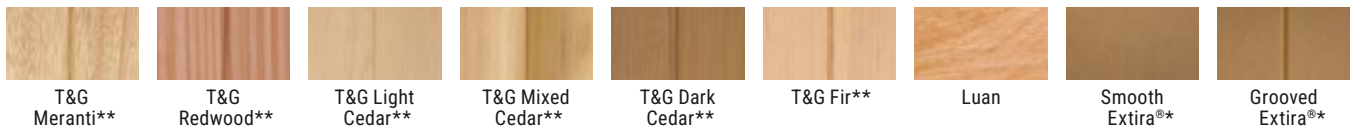

*Extira® wood doors cannot be stained.

**On Tongue-and-Groove (T&G) base doors, the wood species must match overlay species.

WINDCODE® AVAILABILITY CHART

Common Door Widths	W1	W3	W4	W5	W6	W7	W8	
Limited Edition	8', 9' Wide Door	S +13/-15 PSF	SELECT W6	SELECT W6	SELECT W6	F S +39/-45 PSF	SELECT W8	FDW +47/-55 PSF
	10', 12' Wide Door	S +12.5/-14 PSF	SELECT W7	SELECT W7	SELECT W7	SELECT W7	F W +41/-48 PSF	
	16' Wide Door	S +12.5/-14 PSF	SELECT W7	SELECT W7	SELECT W7	SELECT W7	F W +41/-48 PSF	
	18' Wide Door							

S Standard Windows Available
I Impact Rated

W Patented Impact Windows Available
F Florida Approved

D Dade County Approved
T Texas Department of Insurance Approved

For W6-W8 doors over 9' wide, add 2" to the door width.

MODERN

HANDCRAFTED 4-LAYER CONSTRUCTION

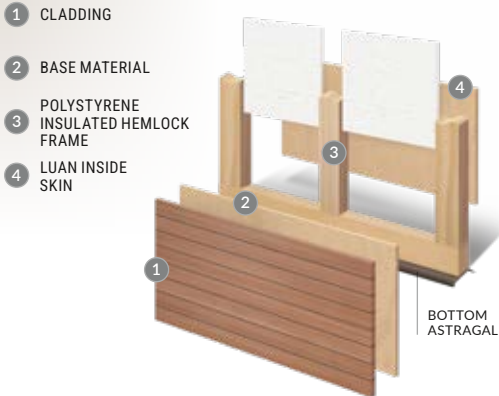

Clean lines and simple forms let the beauty of natural wood stand out. The versatile Reserve® Wood Modern garage doors let you mix materials, shape and tone to create a stunning contemporary garage door that blends beautifully with other woods and materials on your exterior.

STYLE AND CONSTRUCTION

- Handcrafted, 4-layer construction, polystyrene insulated wood door with a 5.9 R-value.
- Built with a sleek contemporary style and convenient upward-acting operation.
- Offset Window models feature a variety of short and long window options that come standard with clear tempered glass.
- Accent Strip models feature decorative flush aluminum accent strips to provide a beautiful contrast of materials. The result is a look that is modern as well as elegant.
- Heavy-duty hinges, rollers and track provide smooth, quiet, long-lasting operation.
- Replaceable vinyl bottom weatherseal in a corrosion-resistant retainer helps seal out the elements.
- All doors can be factory primed or finish painted White. Factory stain available for stained grade wood species.

Calculated door section R-value is in accordance with DASMA TDS-163.

DOOR DESIGNS

Doors shown 8' wide x 7' high.



Accent Strip and Horizontal Cladding models are available spliced and unspliced. Unspliced models are available up to 10' wide.

OFFSET WINDOW DESIGNS



All right-hand designs are shown. Designs 1, 3, 5 and 6 are also available left-handed. *Not available 10'1" to 13'6". Special order only.

SPECIALTY GLASS OPTIONS



Windows are single pane and double strength 1/8" thick. Additional charges for optional glass apply.

MATERIAL OPTIONS



WINDCODE® AVAILABILITY CHART

Common Door Widths		W1	W3	W4	W5	W6	W7	W8
Modern	8', 9' Wide Door	S +13/-15 PSF	SELECT W6	SELECT W6	SELECT W6	F S +39/-45 PSF	SELECT W8	FD +47/-55 PSF
	10', 12' Wide Door	S +12.5/-14 PSF	SELECT W7	SELECT W7	SELECT W7	SELECT W7	F +41/-48 PSF	
	16' Wide Door	S +12.5/-14 PSF	SELECT W7	SELECT W7	SELECT W7	SELECT W7	F +41/-48 PSF	
	18' Wide Door							

S Standard Windows Available
 Impact Rated

W Patented Impact Windows Available
 F Florida Approved

D Dade County Approved
 T Texas Department of Insurance Approved

For W6-W8 doors over 9' wide, add 2" to the door width.

SEMI-CUSTOM

HANDCRAFTED 2-LAYER CONSTRUCTION

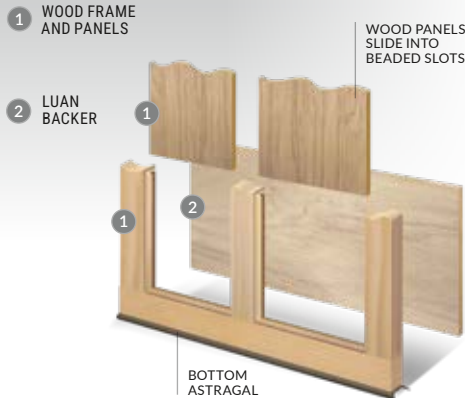

Just because your garage door is a standard size doesn't mean it deserves a standard, cookie-cutter door. That's why Clopay has created its Reserve® Wood Semi-Custom garage doors. These upward-acting wood doors operate just like conventional, modern garage doors.

STYLE AND CONSTRUCTION

- Handcrafted, 2-layer wood doors. Swing-out appearance – modern operation.
- Semi-Custom available in 6 door designs and 10 window or top sections for multiple door design options.
- Windows are single pane and double strength 1/8" thick.
- Premium grade hardware, rollers and track assure smooth, quiet, long-lasting operation.

SPECIALTY GLASS OPTIONS



DOOR DESIGNS

Doors shown 8' wide x 7' high.

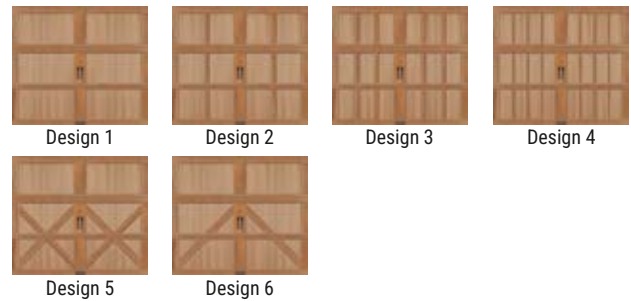

WINDOW OPTIONS



MATERIAL OPTIONS

		STAIN GRADE			PAINT GRADE	
STILE/RAILS	Redwood	Cedar	Hemlock	Hemlock	Hemlock	
PANELS	Redwood	Cedar	Hemlock	Smooth Extira®	Grooved Extira®	

Differences in grain and color variations are indicative of natural wood.

Paint grade and grooved doors cannot be stained.

WINDCODE® AVAILABILITY CHART

Common Door Widths		W1	W3	W4	W5	W6	W7	W8
Semi-Custom	8', 9' Wide Door	S +13/-15 PSF	SELECT W5	SELECT W5	F S +32/-36 PSF			
	10', 12' Wide Door	S +12/-14 PSF	SELECT W5	SELECT W5	F S* +30/-33.3 PSF			
	16' Wide Door	S +12/-14 PSF	SELECT W5	SELECT W5	F S* +30/-33.3 PSF			
	18' Wide Door							

S Standard Windows Available
 Impact Rated

W Patented Impact Windows Available
 F Florida Approved

D Dade County Approved
 T Texas Department of Insurance Approved

*Available only in Hemlock.

FACTORY FINISHES



Clopay stain-grade wood doors of any species are available in nine beautiful stain colors. Custom stain and paint color finishes are available upon request. See your Clopay Dealer for the Clopay Wood brochure or to view stained wood samples in person.



*Note: Printed colors shown here may vary from actual product colors. Clopay stain colors shown on Hemlock wood.
Custom colors are available.

3-LAYER STAIN PROCESS

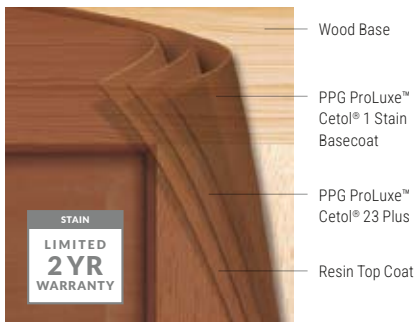

3-LAYER PAINT PROCESS



WOOD DOOR CARE

- Proper care and maintenance are imperative to the appearance, longevity and performance of all wood doors.
- Doors must be painted or stained on all six sides prior to installation. Failure to follow the installation and maintenance instructions will void the warranty.
- Please refer to the installation and maintenance manual or go to www.clopaydoor.com for additional information about caring for a wood door.

PRODUCT SELECTION CHART

Garage Door	Type	Model/Design	Door/Panel Style	Sect. Hts.	Construction/Material	Colors
Avante®		AX/AXU with Section Joint Seal	Contemporary	18", 21", 24"	Aluminum Frame + Glass/Acrylic Panels Aluminum Frame + Aluminum Panels	Clear Aluminum Anodized, Standard White, Bronze Painted, Chocolate Painted, Bronze Anodized, Black Anodized, Dark Bronze Anodized or Powder Coated Custom Colors
VertiStack Avante®		VSAX/VSA XU with Section Joint Seal	Contemporary	18", 21", 24"	Aluminum Frame + Glass/Acrylic Panels Aluminum Frame + Aluminum Panels	Clear Aluminum Anodized, Standard White, Bronze Painted, Chocolate Painted, Bronze Anodized, Black Anodized, Dark Bronze Anodized or Powder Coated Custom Colors
Avante® Sleek		AZ6, AZ6U with Section Joint Seal	Contemporary	18", 21", 24"	Aluminum Frame + Glass	Standard White, Bronze Painted, Chocolate Painted, Bronze Anodized, Black Anodized, Dark Bronze Anodized or Powder Coated Custom Colors
Canyon Ridge®	Carriage House 5-Layer	15 Door Designs, 14 Window or Solid Top Section Designs	Carriage House	18", 21", 24"	5 Layers: Clear Cypress, Mahogany and Pecky Cypress textures; Steel + 2" Intellicore® Polyurethane Insulation + Steel + Cladding + Overlay ⁷	Medium Finish, Dark Finish, Walnut Finish, Slate Finish, Bronze Finish, Charcoal Finish, Black Finish, White Finish, Primed (for those wishing to custom paint or stain their door)
Canyon Ridge®	Carriage House 4-Layer	14 Door Designs, 14 Window or Solid Top Section Designs	Carriage House	18", 21", 24"	4 Layers: Clear Cypress, Mahogany and Ultra-Grain®/Solid Steel textures; Steel + 2" Intellicore® Polyurethane Insulation + Steel + Overlay ⁷	Ultra-Grain® Cypress: Medium, Walnut and Slate Finishes, Bronze Finish, Charcoal Finish, Black Finish, White Finish, Primed (for those wishing to custom paint or stain their door)
Canyon Ridge®	Elements	13 Door Designs, 10 Window or Solid Top Section Designs	Carriage House	18", 21", 24"	4 Layers: Steel + 1-3/8" Bonded Polystyrene Insulation + Steel + Composite	Standard White, Almond, Desert Tan, Sandtone, Bronze, Charcoal, Black
Canyon Ridge®	Chevron	8 Door Designs, 4 Cladding Design Options, 14 Window or Solid Top Section Designs	Carriage House	18", 21", 24"	5 Layers: Clear Cypress, Mahogany and Pecky Cypress textures; Steel + 2" Intellicore® Polyurethane Insulation + Steel + Cladding + Overlay ⁷	Medium Finish, Dark Finish, Walnut Finish, Slate Finish, Bronze Finish, Charcoal Finish, Black Finish, White Finish, Primed (for those wishing to custom paint or stain their door)
Canyon Ridge®	Louver	12 Door Designs, 6 Window or Solid Top Section Designs	Plantation Shutter	18", 21", 24"	5 Layers: Clear Cypress, Mahogany, Ultra-Grain®/Solid Steel and Lower Mahogany textures; Steel + 2" Intellicore® Polyurethane Insulation + Steel + Cladding + Overlay ⁷	Medium Finish, Dark Finish, Walnut Finish, Slate Finish, Bronze Finish, Charcoal Finish, Black Finish, White Finish, Primed (for those wishing to custom paint or stain their door)
Canyon Ridge®	Modern	3 Door Designs	Contemporary	18", 21", 24"	4 Layers: Clear Cypress and Mahogany textures; Steel + 2" Intellicore® Polyurethane Insulation + Steel + Cladding or Overlay ⁷	Medium Finish, Dark Finish, Walnut Finish, Slate Finish, Bronze Finish, Charcoal Finish, Black Finish, White Finish, Primed (for those wishing to custom paint or stain their door)
Coachman®		15 Door Designs, 10 Window or Solid Top Section Designs	Carriage House	18", 21", 24"	4 Layers: Steel + 2" Intellicore® Polyurethane Insulation + Steel + Composite ⁷ Steel + 2" Bonded Polystyrene Insulation + Steel + Composite ⁷ Steel + 1-3/8" Bonded Polystyrene Insulation + Steel + Composite	Base: Standard White, Almond, Desert Tan, Sandtone Overlay: Standard White, Almond, Desert Tan, Sandtone
Grand Harbor®		8 Door Designs, 16 Window or Solid Top Section Designs	Carriage House	18", 24"	3 or 2 Layers: Composite + Steel + Insulation, Composite + Steel	Base: Standard White, Almond, Desert Tan, Sandtone Overlay: Standard White
Gallery® Steel	Three-Layer	2 Door Designs, 25 Window or Solid Top Section Designs	Carriage House	18", 21", 24"	3 Layers: Steel + 2" Intellicore® Polyurethane Insulation + Steel ⁷ Steel + 1-3/8" Intellicore® Polyurethane Insulation + Steel ⁷ Steel + 2" Bonded Polystyrene Insulation + Steel ⁷ Steel + 1-3/8" Bonded Polystyrene Insulation + Steel	Standard White, Almond, Desert Tan, Sandtone, Bronze, Chocolate, Mocha Brown, Charcoal, Black, Lustra™ Black, Lustra™ Charcoal, Lustra™ Silver, Ultra-Grain® Oak: Medium, Dark, Walnut and Slate Finishes
Gallery® Steel	Two-Layer and One-Layer	2 Door Designs, 25 Window or Solid Top Section Designs	Carriage House	18", 21", 24"	2 or 1 Layers: Steel + 1-5/16" Polystyrene Insulation; Steel	Standard White, Almond, Desert Tan, Sandtone, Chocolate, Black, Ultra-Grain® Oak: Walnut and Slate Finishes ²
Bridgeport™ Steel	Three-Layer	2 Door Designs, 25 Window or Solid Top Section Designs	Shaker (Narrow and Extended Recessed)	18", 21", 24"	3 Layers: Steel + 2" Intellicore® Polyurethane Insulation + Steel ⁷ Steel + 1-3/8" Intellicore® Polyurethane Insulation + Steel ⁷	Standard White, Almond, Desert Tan, Sandtone, Bronze, Chocolate, Mocha Brown, Charcoal, Black, Lustra™ Black, Lustra™ Charcoal, Lustra™ Silver, Ultra-Grain® Oak: Medium, Dark, Walnut and Slate Finishes
Bridgeport™ Steel	Two-Layer and One-Layer	2 Door Designs, 25 Window or Solid Top Section Designs	Shaker (Narrow and Extended Recessed)	18", 21", 24"	2 or 1 Layers: Steel + 1-5/16" Polystyrene Insulation; Steel	Standard White, Almond, Desert Tan, Sandtone, Chocolate, Black, Ultra-Grain® Oak: Walnut and Slate Finishes ²
Garage Door	Type	Model/Design	Door/Panel Style	Sect. Hts.	Construction/Material	Colors
Modern Steel™	Premium	9202, 9201 No Panel	Modern Flush	18", 21", 24"	3 Layers: Steel + 2" Intellicore® Polyurethane Insulation + Steel ⁷	Standard White, Almond, Desert Tan, Sandtone, Bronze, Chocolate, Mocha Brown, Charcoal, Black, Hunter Green ⁵ , Gray, Ultra-Grain® Cypress: Medium, Cherry, Walnut and Slate Finishes ⁴
Modern Steel™	Premium	9208 No Panel	Modern Flush	18", 21", 24"	3 Layers: Steel + 2" Intellicore® Polyurethane Insulation + Steel ⁷	Standard White, Almond, Desert Tan, Sandtone, Bronze, Chocolate, Mocha Brown, Charcoal, Black, Gray, Lustra™ Black, Lustra™ Charcoal, Lustra™ Silver, Ultra-Grain® Cypress: Medium, Cherry, Walnut and Slate Finishes, Ultra-Grain® Plank: Coastal Gray, Natural, Cedar, Kona, Barnwood and Espresso Finishes
Modern Steel™	Premium	9205 No Panel	Modern Grooved	18", 21", 24"	3 Layers: Steel + 2" Intellicore® Polyurethane Insulation + Steel ⁷	Standard White, Almond, Desert Tan, Sandtone, Bronze, Chocolate, Mocha Brown, Charcoal, Black, Gray, Ultra-Grain® Cypress: Medium, Cherry, Walnut and Slate Finishes
Modern Steel™	Premium	9209 No Panel	Modern Grooved	18", 21", 24"	3 Layers: Steel + 2" Intellicore® Polyurethane Insulation + Steel ⁷	Standard White, Almond, Desert Tan, Sandtone, Bronze, Chocolate, Mocha Brown, Charcoal, Black, Gray, Lustra™ Black, Lustra™ Charcoal, Lustra™ Silver, Ultra-Grain® Cypress: Medium, Cherry, Walnut and Slate Finishes
Modern Steel™	Premium	9132, 9138 No Panel	Modern Flush	18", 21", 24"	3 Layers: Steel + 1-3/8" Intellicore® Polyurethane Insulation + Steel ⁷	Standard White, Almond, Desert Tan, Sandtone, Bronze, Chocolate, Mocha Brown, Charcoal, Black, Hunter Green ⁵ , Gray, Ultra-Grain® Cypress: Medium, Cherry, Walnut and Slate Finishes ⁴
		9131		18", 21"		
Modern Steel™	Premium	9139 No Panel	Modern Grooved	18", 21", 24"	3 Layers: Steel + 1-3/8" Intellicore® Polyurethane Insulation + Steel ⁷	Standard White, Almond, Desert Tan, Sandtone, Bronze, Chocolate, Mocha Brown, Charcoal, Black, Gray, Ultra-Grain® Cypress: Medium, Cherry, Walnut and Slate Finishes
Modern Steel™	Premium	4302, 4308 No Panel	Modern Flush	18", 21", 24"	3 Layers: Steel + 2" Bonded Polystyrene Insulation + Steel ⁷	Standard White, Almond, Desert Tan, Sandtone, Bronze, Chocolate, Mocha Brown, Charcoal, Black, Hunter Green ⁵ , Gray, Ultra-Grain® Cypress: Medium, Cherry, Walnut and Slate Finishes ⁴
		4301		18", 21"		
Modern Steel™	Premium	4305, 4309 No Panel	Modern Grooved	18", 21", 24"	3 Layers: Steel + 2" Bonded Polystyrene Insulation + Steel ⁷	Standard White, Almond, Desert Tan, Sandtone, Bronze, Chocolate, Mocha Brown, Charcoal, Black, Gray, Ultra-Grain® Cypress: Medium, Cherry, Walnut and Slate Finishes
Modern Steel™	Premium	4132 No Panel	Modern Flush	18", 21", 24"	3 Layers: Steel + 1-3/8" Bonded Polystyrene Insulation + Steel	Standard White, Almond, Desert Tan, Sandtone, Bronze, Chocolate, Mocha Brown, Charcoal, Black, Gray, Ultra-Grain® Cypress: Medium, Cherry, Walnut and Slate Finishes
Modern Steel™	Premium	4051 No Panel	Modern Flush	18", 21"	3 Layers: Steel + 1-3/8" Bonded Polystyrene Insulation + Steel	Standard White, Almond, Desert Tan, Sandtone, Bronze, Chocolate, Black
Modern Steel™	Premium	4138 No Panel	Modern Flush	18", 21", 24"	3 Layers: Steel + 1-3/8" Bonded Polystyrene Insulation + Steel	Standard White, Almond, Desert Tan, Sandtone, Bronze, Chocolate, Mocha Brown, Charcoal, Black, Gray, Ultra-Grain® Cypress: Medium, Cherry, Walnut and Slate Finishes
Modern Steel™	Value	4F No Panel	Modern Flush	18", 21"	1 Layer: Steel	Standard White, Almond, Desert Tan, Sandtone, Chocolate, Black
Modern Steel™	Value	4F4 No Panel	Modern Flush	18", 21"	1 Layer: Steel	Standard White, Almond, Desert Tan, Sandtone, Chocolate

PRODUCT SELECTION CHART

Garage Door	Type	Model/Design	Door/Panel Style	Sect. Hts.	Construction/Material	Colors
Classic™ Steel	Premium	9200 Raised Panel	Elegant Short	18", 21"	3 Layers: Steel + 2" Intellicore® Polyurethane Insulation + Steel ⁷	Standard White, Almond, Desert Tan, Sandtone, Bronze, Chocolate, Mocha Brown, Charcoal, Black, Hunter Green, Gray, Ultra-Grain® Classic: Medium, Cherry and Walnut Finishes
Classic™ Steel	Premium	9203 Raised Panel	Elegant Long	18", 21"	3 Layers: Steel + 2" Intellicore® Polyurethane Insulation + Steel ⁷	Standard White, Almond, Desert Tan, Sandtone, Bronze, Chocolate, Mocha Brown, Charcoal, Black, Hunter Green, Gray, Ultra-Grain® Classic: Medium, Cherry and Walnut Finishes
Classic™ Steel	Premium	9130 Raised Panel	Elegant Short	18", 21"	3 Layers: Steel + 1-3/8" Intellicore® Polyurethane Insulation + Steel ⁷	Standard White, Almond, Desert Tan, Sandtone, Bronze, Chocolate, Mocha Brown, Charcoal, Black, Hunter Green, Gray, Ultra-Grain® Classic: Medium, Cherry and Walnut Finishes
Classic™ Steel	Premium	9133 Raised Panel	Elegant Long	18", 21"	3 Layers: Steel + 1-3/8" Intellicore® Polyurethane Insulation + Steel ⁷	Standard White, Almond, Desert Tan, Sandtone, Bronze, Chocolate, Mocha Brown, Charcoal, Black, Hunter Green, Gray, Ultra-Grain® Classic: Medium, Cherry and Walnut Finishes
Classic™ Steel	Premium	4300 Raised Panel	Elegant Short	18", 21"	3 Layers: Steel + 2" Bonded Polystyrene Insulation + Steel ⁷	Standard White, Almond, Desert Tan, Sandtone, Bronze, Chocolate, Mocha Brown, Charcoal, Black, Hunter Green, Gray, Ultra-Grain® Classic: Medium, Cherry and Walnut Finishes
Classic™ Steel	Premium	4310 Raised Panel	Elegant Long	18", 21"	3 Layers: Steel + 2" Bonded Polystyrene Insulation + Steel ⁷	Standard White, Almond, Desert Tan, Sandtone, Bronze, Chocolate, Mocha Brown, Charcoal, Black, Hunter Green, Gray, Ultra-Grain® Classic: Medium, Cherry and Walnut Finishes
Classic™ Steel	Premium	4050 Raised Panel	Elegant Short	18", 21"	3 Layers: Steel + 1-3/8" Bonded Polystyrene Insulation + Steel	Standard White, Almond, Desert Tan, Sandtone, Bronze, Chocolate, Black
Classic™ Steel	Premium	4053 Raised Panel	Elegant Long	18", 21"	3 Layers: Steel + 1-3/8" Bonded Polystyrene Insulation + Steel	Standard White, Almond, Desert Tan, Sandtone, Bronze, Chocolate, Black
Classic™ Steel	Value Plus	1500 and 15SP Raised Panel	Traditional Short	18", 21"	2 Layers: Steel + 1-5/16" Polystyrene Insulation	Standard White, Almond, Desert Tan, Sandtone, Chocolate
Classic™ Steel	Value Plus	94V Raised Panel	Traditional Short	18", 21"	2 Layers: Steel + 1-5/16" Polystyrene Insulation	Standard White, Almond, Desert Tan, Sandtone, Chocolate, Black
Classic™ Steel	Value Plus	76V and 76VSP Raised Panel	Traditional Long	18", 21"	2 Layers: Steel + 1-5/16" Polystyrene Insulation	Standard White, Almond, Desert Tan, Sandtone, Chocolate
Classic™ Steel	Value ⁶	73 Raised Panel	Traditional Short	18", 21"	1 Layer: Steel	Standard White, Almond, Desert Tan, Sandtone, Chocolate
Classic™ Steel	Value ⁶	94 Raised Panel	Traditional Short	18", 21"	1 Layer: Steel	Standard White, Almond, Desert Tan, Sandtone, Chocolate, Black
Classic™ Steel	Value ⁶	76 Raised Panel	Traditional Long	18", 21"	1 Layer: Steel	Standard White, Almond, Desert Tan, Sandtone, Chocolate
Garage Door	Type	Model/Design	Door/Panel Style	Sect. Hts.	Construction/Material	Finishing Options
Reserve® Wood	Custom	Custom	Carriage House	Varies	5 or 4 Layers: Specified Wood; Insulated	Stained, Finish Painted White, Primed, Unfinished
Reserve® Wood	Limited Edition	8 Door Designs, 13 Window or Solid Top Section Designs	Carriage House	Varies	5 or 4 Layers: Meranti, Cedar, Redwood, Fir, Extrira®, Luan; Insulated	Stained, Finish Painted White, Primed, Unfinished
Reserve® Wood	Modern	3 Door Designs	Contemporary	Varies	4 Layers: Light Cedar, Dark Cedar, Mixed Cedar, Redwood, Fir, Meranti	Stained, Finish Painted White, Primed, Unfinished
Reserve® Wood	Semi-Custom	6 Door Designs, 10 Window or Solid Top Section Designs	Carriage House	22.75", 28"	2 Layers: Hemlock, Cedar, Redwood, Extrira®	Stained, Finish Painted White, Primed, Unfinished

¹ Not available on long panel and 24 gauge extended panel models.

² Not available on 25 gauge models.

³ Available on 2" Intellicore® polyurethane models.

⁴ Not available on Models 9201, 9131 and 4301.

⁵ Not available on Models 9202, 9132, 9138, 4302, 4308.

Mocha Brown is not available on impact rated windows. Additional charges for optional glass apply. Clopay's patents mentioned throughout are 9,022,091 for impact rated windows, D719,280 and D755,409 for tapered strut.

⁶ Not all models available in all regions. See your Clopay Dealer for model availability in your region.

⁷ Models come standard with 10-ball nylon rollers and heavy-duty 14 gauge steel hinges.

These models also comply with 2015 IECC air infiltration requirement of 0.40 cfm/ft² or less (IECC, Section C402.5.2).

Effective December 2024
(Subject to change without notice)



Canyon Ridge® / Carriage House 4-Layer, Design 11; Shown in Ultra-Grain® Cypress Medium Finish with Clear Cypress Overlays in Medium Finish
Photo Credit: Andy Frame Photography

Modern Steel™ / Modern Flush Panel; Shown in Ultra-Grain® Cypress
Medium Finish with Plain Long Windows down left side
Photo Credit: Healthier Homes by JS2 Partners



Visit clopaydoor.com or call **1-800-2CLOPAY (225-6729)** for more information on Clopay, America's Favorite Garage Doors.

Follow us on

MADE IN USA



©2024 Clopay Corporation. All rights reserved.

RSDR-WCBRFL-12_REV1224



**START DESIGNING
YOUR NEW
GARAGE DOOR
OPEN CAMERA
AND POINT!**